



TRAMONTINA

CHURRASCO

2018



TRAMONTINA
INOX STAINLESS

MADE IN BRAZIL



TRAMONTINA

CHURRASCO



Assar a carne sobre o fogo é uma antiga tradição que surgiu no Sul do Brasil e, que hoje, faz o maior sucesso em todo o país. Foi na região dos Pampas que os primeiros churrasqueiros deixavam todo mundo com água na boca apenas com espetos improvisados de madeira e fogo de chão. Com o passar dos anos e com a ajuda da Tramontina, o churrasco evoluiu. Isso porque nós respeitamos como ninguém a tradição do churrasco. E criamos uma linha completa de espetos, grelhas, facas, churrasqueiras e tudo o que você precisa para fazer um verdadeiro churrasco. Digno de um Mestre Churrasqueiro.



Roasting meat over a fire is a long-standing tradition that began in Southern Brazil and today is very popular all over the country. It was in the Pampas region that the first meat roasters made everyone's mouth water using improvised wooden spits and campfires. As years went by and with Tramontina's help, the traditional barbecue evolved. That's because we respect the "churrasco" tradition like no one else. We created a complete line of spits, cooking grates, knives, barbecue grills, and everything else you need to make a proper barbecue. Fit for a true churrasco master.



Asar la carne sobre el fuego es una vieja tradición que surgió en el sur de Brasil y que hoy es el mayor éxito en todo el país. Fue en la Región de los Pampas que los primeros asadores dejaban a todo el mundo encantado apenas con pinchos de madera improvisados y una fogata en el suelo. Con el pasar de los años y con ayuda de Tramontina, el asado evolucionó. Eso ocurrió porque nosotros respetamos como nadie la tradición del asado. Y creamos una línea completa de pinchos, parrillas, cuchillos, grills y todo lo que se precisa para hacer un verdadero asado. Digno de un maestro asador.



TRAMONTINA

CHURRASCO





TRAMONTINA

CHURRASCO

CHURRASQUEIRA À CARVÃO CHARCOAL BARBECUE GRILL | GRILL A CARBÓN

26500/002
TCP-320

Churrasqueira a carvão
Charcoal barbecue grill
Grill a carbón

*A= 35,9 cm
*B= 36,7 cm
*C= 26,1 cm

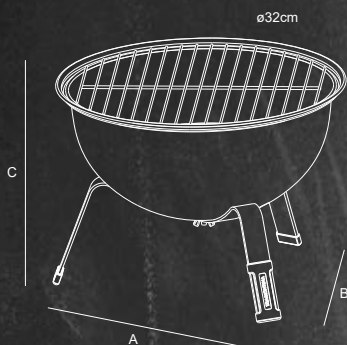

- Fácil montagem, manuseio e armazenamento.
- Baixo consumo de carvão.
- Corpo e bandeja para carvão de aço esmaltado.
- Grelha de aço inox.
- Utensílio para manusear a grelha.
- Apoios de silicone que asseguram melhor estabilidade.
- Quantidade de carvão recomendada 1,0Kg.

- Easy to assemble, use, and store.
- Low charcoal consumption.
- Enameled steel body, and charcoal tray.
- Stainless steel cooking grate.
- Utensil for handling cooking grate.
- Silicone supports for better stability.
- Recommended amount of charcoal: 1,0 kg.

- Fácil montaje, manejo y almacenaje.
- Poco consumo de carbón.
- Cuerpo y bandeja para carbón de acero esmaltado.
- Parrilla de acero inoxidable.
- Utensilio para manejar la parrilla.
- Apoyos de silicona que garantizan mejor estabilidad.
- Cantidad de carbón recomendada 1,0 kg.

26500/003
TCP-320L

Churrasqueira a carvão
Charcoal barbecue grill
Grill a carbón

*A= 36,7 cm
*B= 37,1 cm
*C= 44,1 cm



- Fácil montagem, manuseio e armazenamento.
- Baixo consumo de carvão.
- Corpo, tampa e bandeja para carvão de aço esmaltado.
- Grelha de aço inox.
- Pegador de baquelite e saída de vapor.
- Utensílio para manusear a grelha.
- Apoios de silicone que asseguram melhor estabilidade.
- Quantidade de carvão recomendada 1,0Kg.

- Easy to assemble, use, and store.
- Low charcoal consumption.
- Enameled steel body, lid and charcoal tray.
- Stainless steel cooking grate.
- Bakelite lid handle with steam vent.
- Utensil for handling cooking grate.
- Silicone supports for better stability.
- Recommended amount of charcoal: 1,0 kg.

- Fácil montaje, manejo y almacenaje.
- Poco consumo de carbón.
- Cuerpo, tapa y bandeja para carbón de acero esmaltado.
- Parrilla de acero inoxidable.
- Manija de baquelita con salida de vapor.
- Utensilio para manejar la parrilla.
- Apoyos de silicona que garantizan mejor estabilidad.
- Cantidad de carbón recomendada 1,0 kg.



TRAMONTINA

CHURRASCO



26500/005

TCP-320F

Churrasqueira a carvão
Charcoal barbecue grill
Grill a carbón

*A= 36,7 cm

*B= 36,9 cm

*C= 55,1 cm



- Alça antitérmica.
- Heat resistant handle.
- Asa antitérmica.

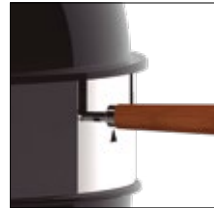

- Anel em aço inox. Maior resistência à corrosão. Encaixe com ajustes para espetos.
- Stainless Steel rim. Greater resistance to corrosion. With slots for skewers.
- Aro de acero inoxidable. Mayor resistencia a la corrosión. Encajes con ajuste para espiedos.



- Controle de saída de ar em aço inox.
- Stainless steel air control vents.
- Control de salida de aire de acero inoxidable.



- Proteções de silicone. Isolante térmico. Maior estabilidade.
- Silicone protection. Heat resistant feet. Greater stability.
- Protecciones de silicona. Aislante térmico. Más estabilidad.

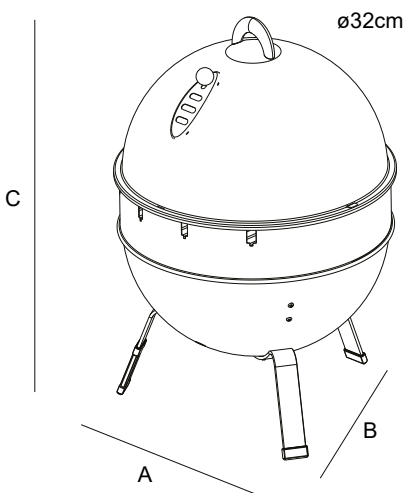

*Espetos não acompanham o produto

Skewers not included

Pinchos no siguen con el producto

- Corpo e tampa em aço esmaltado.
- Entradas de ar.
- Sistema de fácil montagem.
- Grelha em aço inox.
- Bandeja em aço inox para carvão.

- Enameled steel body and lid.
- Air vents.
- Easy to assemble.
- Stainless steel cooking grill.
- Stainless steel charcoal tray.

- Cuerpo y tapa de acero esmaltado.
- Entradas de aire.
- Sistema de fácil montaje.
- Rejilla de acero inoxidable.
- Bandeja de acero inoxidable para carbón.



**A CHURRASQUEIRA DE TAMBOR MUDOU.
FICOU MAIS MODERNA, MAIS SEGURA E MUITO
MAIS EFICIENTE.**

**GANHOU ATÉ UM NOVO NOME:
É A TCP-400, UM LANÇAMENTO
DA TRAMONTINA QUE VEIO
PARA RENOVAR A TRADIÇÃO
DE FAZER BONITO.**

**THE DRUM BARBECUE GRILL HAS CHANGED.
IT IS NOW SAFER, MORE MODERN, AND
MUCH MORE EFFICIENT.**

**IT EVEN HAS A NEW NAME:
THE TCP-400, A NEW RELEASE
FROM TRAMONTINA TO RENEW
THE TRADITION OF DOING THINGS
BEAUTIFULLY WELL.**

**LA PARRILLA DE MEDIO TANQUE CAMBIÓ.
AHORA ES MÁS MODERNA, MÁS SEGURA Y
MUCHO MÁS EFICIENTE.**

**SE GANÓ HASTA UN NOMBRE:
ES LA TCP-400, UN LANZAMIENTO
DE TRAMONTINA QUE VIENE
PARA RENOVAR LA TRADICIÓN
DE HACER BIEN LAS COSAS.**

A releitura de uma história de paixão pelo churrasco.

Talvez você a conheça como churrasqueira de tonel. Ou de latão. O nome varia de um lugar para outro, mas tradição é a mesma: improvisar o churrasco em um equipamento simples, prático e fácil de montar. Há quase um século, tambores de aço são usados como churrasqueiras que funcionam a qualquer hora, em qualquer lugar. Elas já se tornaram parte do cotidiano de quem vive a paixão pelo churrasco. Agora, a Tramontina honra essa tradição com a TCP-400, uma churrasqueira inovadora que combina a praticidade do tambor com os diferenciais do aço inox, além de um design de alta performance. É a churrasqueira de tambor que você já conhece, mas com vantagens que você nunca viu.

This is a rereading of a history of passion for barbecue.

Maybe you know it as barrel grill. Or tin grill. The name varies according to the region, but the tradition remains the same: improvising your barbecue in a simple, practical, and easy-to-assemble piece of equipment. For nearly one century, steel drums have been used as barbecue grills that can work anytime, anywhere. They have become part of the daily routine of those who are passionate about barbecue. Tramontina now honors this tradition with the TCP-400, an innovative barbecue grill which combines the practicality of the drum with the distinguishing features of stainless steel coupled with a high-performance design. This is the drum barbecue grill that you have always known, but with advantages that you have never seen.

La re edición de una historia de pasión por el asado.

Tal vez usted la conozca como parrilla de medio tanque. O de lata. El nombre cambia de un lugar a otro, pero la tradición es la misma: improvisar el asado en un equipo simple, práctico y fácil de armar. Hace casi un siglo, los tanques de acero se usan como parrillas que funcionan a cualquier hora y en cualquier lugar. Se convierten en parte de lo cotidiano de quienes viven la pasión por el asado. Ahora, Tramontina honra esa tradición con la TCP-400, una parrilla innovadora que combina la practicidad del medio tanque con los beneficios del acero inoxidable, además de un diseño de alto desempeño. Es la parrilla de medio tanque que usted ya conoce, pero con ventajas que usted nunca vio.

TRAMONTINA

CHURRASCO

26500/007

TCP-400

Churrasqueira a carvão
Charcoal barbecue grill
Grill a carbón

*A= 40,8 cm

*B= 41,9 cm

*C= 74,9 cm

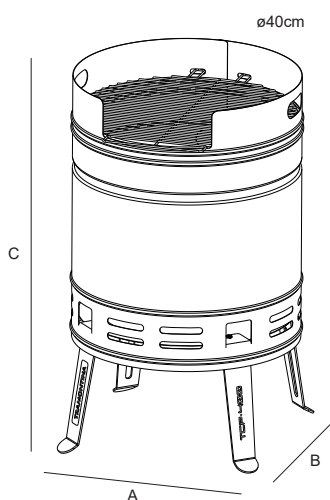

A QUALIDADE EM TODO LUGAR

A Tramontina desenvolveu a TCP-400 especialmente para você que deseja fazer mais com sua churrasqueira. Confira seus diferenciais.

QUALITY EVERYWHERE

Tramontina has developed TCP-400 especially for those who wish to do more with their grill. Check out its distinguishing features.

LA CALIDAD EN TODOS LOS LUGARES

Tramontina desarrolló la TCP-400 especialmente para usted, que desea hacer más con su parrilla. Vea sus características.

ALTA PERFORMANCE

O design da TCP-400 concentra o calor onde realmente importa – na carne. O churrasco fica mais uniforme e a gordura derrete melhor, realçando o sabor e aquele cheirinho irresistível.

HIGH PERFORMANCE

The TCP-400 design concentrates the heat where it really matters – on the meat. The barbecue cooks more evenly and the fat melts better, highlighting the flavor and that irresistible aroma.

ALTO DESEMPEÑO

El diseño de la TCP-400 concentra el calor donde realmente importa: en la carne. El asado queda más parejo y la grasa se derrite mejor, realzando el sabor y aquel olorcito irresistible.

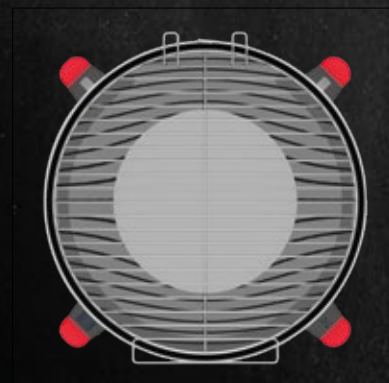

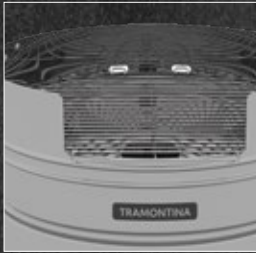

CHURRASCO MUITO MAIS SUCULENTO

A TCP-400 vem com proteções laterais que protegem a carne contra o vento, preservando melhor o aroma e o sabor.

A JUICIER BARBECUE

The TCP-400 includes side barriers to shield the meat from the wind, better preserving the flavor and aroma.

ASADO MUCHO MÁS SUCULENTO

La TCP-400 viene con protecciones laterales que protegen la carne contra el viento, preservando mejor el aroma y sabor.



DURABILIDADE SUPERIOR

O corpo da TCP-400 é 100% aço inox, que dura muito mais do que as tradicionais churrasqueiras de aço esmaltado.

SUPERIOR DURABILITY

The body of the TCP-400 is 100% stainless steel, which lasts much longer than traditional enameled steel grills.

DURABILIDAD SUPERIOR

El cuerpo de la TCP-400 es totalmente de acero inoxidable, que dura mucho más que las parrillas tradicionales de acero esmaltado.



FÁCIL DE USAR

Coloque o carvão, manuseie a grelha e mantenha o assado sempre ao alcance das suas mãos.

EASY TO USE

Adjust the charcoal, handle the grate, and keep your roast always within reach.

FÁCIL DE USAR

Regule el carbón, maneje la parrilla y mantenga el asado siempre al alcance de sus manos.



MAIS ECONOMIA

A TCP-400 foi projetada para você preparar um churrasco completo usando apenas 1,5 kg de carvão.

MORE SAVINGS

The TCP-400 was designed for you to prepare a complete barbecue dinner using only 1.5kg of charcoal.

MÁS AHORRO

La TCP-400 se diseñó para que usted prepare un asado completo usando apenas 1,5 kg. de carbón.

CHURRASQUEIRA 100% MONTADA

- Melhor desempenho, design que favorece o fluxo de calor, acelerando o cozimento.
- Fácil manuseio e armazenamento.
- Baixo consumo de carvão.
- Corpo, prato e grelha de aço inox.
- Quantidade de carvão recomendada 1,5Kg.

100% ASSEMBLED GRILL

- Better performance and a design that facilitates heat flow, speeding up cooking time.
- Easy to use and store.
- Low charcoal consumption.
- Stainless steel body, plate, and cooking grate.
- Recommended amount of charcoal: 1.5 kg.

GRILL TOTALMENTE ARMADO

- Mejor desempeño, diseño que favorece el flujo de calor, acelerando la cocción.
- Fácil manejo y almacenaje.
- Poco consumo de carbón.
- Cuerpo, plato y parrilla de acero inoxidable.
- Cantidad de carbón recomendada 1,5 kg.

CHURRASCO

26500/008

TCP-450

Churrasqueira a carvão
Charcoal barbecue grill
Grill a carbón

*A= 51,6 cm
*B= 53,1 cm
*C= 73,6 cm

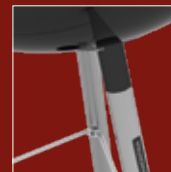

- Fácil montagem, manuseio e armazenamento.
- Easy to assemble, use, and store.
- Fácil montaje, manejo y almacenaje.

- Baixo consumo de carvão.
- Corpo e bandeja para carvão de aço esmaltado.
- Pernas e grelha de aço inox.
- Utensílio para mansear a grelha.
- Quantidade de carvão recomendada 2,0Kg.

- Low charcoal consumption.
- Enameled steel body and charcoal tray.
- Stainless steel legs and cooking grate.
- Utensil for handling cooking grate.
- Recommended amount of charcoal: 2.0 kg.

- Poco consumo de carbón.
- Cuerpo y bandeja para carbón de acero esmaltado.
- Patas y parrilla de acero inoxidable.
- Utensilio para manejar la parrilla.
- Cantidad de carbón recomendada 2,0 kg.

26500/009

TCP-450L

Churrasqueira a carvão
Charcoal barbecue grill
Grill a carbón

*A= 51,6 cm
*B= 53,4 cm
*C= 97,3 cm

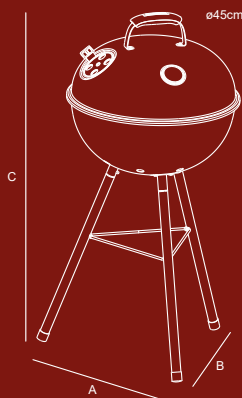

- Controle de saída de ar
- Air control vents.
- Control de salida de aire

- Fácil montagem, manuseio e armazenamento.
- Baixo consumo de carvão.
- Corpo, tampa e bandeja para carvão de aço esmaltado.
- Pernas e grelha de aço inox.
- Controle de saída de ar
- Termômetro para controle de temperatura interna.
- Utensílio para mansear grelha.
- Quantidade de carvão recomendada 2,0Kg.

- Easy to assemble, use, and store.
- Low charcoal consumption.
- Enameled steel body, lid and charcoal tray.
- Stainless steel legs and cooking grate.
- Grill vents.
- Thermometer to control internal temperature.
- Utensil for handling cooking grate.
- Recommended amount of charcoal: 2.0 kg.

- Fácil montaje, manejo y almacenaje.
- Poco consumo de carbón.
- Cuerpo, tapa y bandeja para carbón de acero esmaltado.
- Patas y parrilla de acero inoxidable.
- Control de salida de aire.
- Termómetro para control de la temperatura interna.
- Utensilio para manejar la parrilla.
- Cantidad de carbón recomendada 2,0 kg.



NEW

26500/054

Anel para espetos TCP-450 e TCP-450L

TCP-450 and TCP-450L Grill support for skewers
Anillo para pinchos TCP-450 y TCP-450L

Encaixe para espetos Tramontina com comprimento total de 65cm.
With fitting Tramontina skewers with 65cm

Con encajes indicados para pinchos Tramontina com tamaño total de 65cm.



NEW

26500/011

TCP-560L

Churrasqueira a carvão
Charcoal barbecue grill
Grill a carbón

*A= 104cm
*B= 64,5cm
*C= 64,6cm



- Tampa em aço carbono esmaltado
- Termômetro em aço inox
- Alça da tampa e do corpo fabricada em nylon reforçado com fibra de vidro
- Tampa com respiro de ar de aço inox com manípulo de nylon reforçado com fibra de vidro
- Corpo em aço carbono esmaltado
- Grelha em aço inox
- Prato para carvão em aço carbono esmaltado
- Pernas em aço inox
- Suporte das pernas em alumínio fundido com pintura epóxi
- Apoio da perna frontal em polipropileno
- Rodas com revestimento emborrachado
- Grade inferior em aço inox
- Utensílio para manusear grelha

- Enameled carbon steel lid
- Stainless steel thermometer
- Lid and bowl handle made of fiberglass reinforced nylon
- Lid with stainless steel air vent with fiberglass reinforced nylon handle
- Enameled carbon steel body
- Stainless steel cooking grate
- Enameled steel charcoal tray
- Stainless steel leg
- Cast aluminium leg holder with epoxy paint
- Polypropylene front leg support
- Rubber-coated wheels
- Stainless steel bottom grate
- Utensil for handling cooking grate

- Tapa de acero al carbono esmaltada
- Termómetro de acero inoxidable
- Mango de tapa y tazón de nylon reforzado con fibra de vidrio
- Tapa con ventilación de acero inoxidable con mango de nylon reforzado con fibra de vidrio
- Cuerpo de acero al carbono esmaltado
- Parrilla de cocina de acero inoxidable
- Bandeja de carbón de acero esmaltada
- Piernas de acero inoxidable
- Soporte de pierna de aluminio fundido con pintura epoxi
- Soporte delantero de polipropileno
- Ruedas recubiertas de goma
- Parrilla inferior de acero inoxidable
- Utensilio para manejar la parrilla



26500/029

Anel para espetos TCP-560L

TCP-560L Grill Support for skewers
Anillo para pinchos TCP-560L

Encaixe para espetos Tramontina com comprimento total de 75cm.
With fitting Tramontina skewers with 75cm
Con encajes indicados para pinchos Tramontina com tamaño total de 75cm.



TRAMONTINA

TRAMONTINA

CHURRASCO

CHURRASQUEIRA A GÁS GAS GRILL I GRILL A GAS



26500/015

TGP-1050

Churrasqueira a gás

Gas grill

Grill a gas

*A= 38 cm

*B= 57,2 cm

*C= 57,8 cm

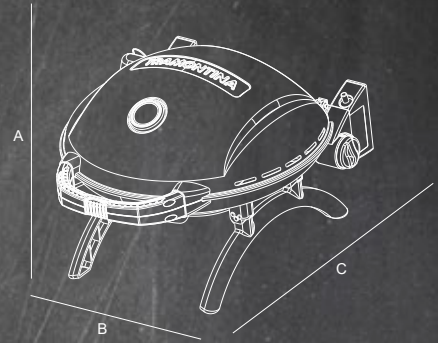

- Botão de acendimento automático. Não necessita de energia elétrica.
- Automatic igniter switch. No electric power required.
- Botón de encendido automático. No precisa energía eléctrica.



- Trava para transporte.
- Locking handle.
- Traba para transporte.



- Medidor de temperatura interna.
- Internal temperature gauge.
- Medidor de temperatura interna.



- Grelha em ferro fundido esmaltado. Mais robustez e maior resistência ao desgaste.
- Enameled cast iron grate. Stronger and greater wear resistance.
- Parrilla de hierro fundido esmaltado. Más robustez y más resistencia al desgaste.



- Suportes dobráveis.
- Foldable legs.
- Soportes plegables.



- Corpo e tampa com revestimento poliéster siliconado.
- Suporte para acendimento com fósforo.
- Conexão para cilindros ou botijões. Versatilidade para o uso.
- Bandeja coletora de gordura em alumínio.
- Botão de controle de vazão de gás.
- Design que favorece a distribuição do calor. Melhor desempenho.
- Queimador em aço inox.
- Facilidade no transporte e armazenamento.

- Steel body and lid with silicone polyester coating.
- Can also be lit with matches.
- Connection for gas cylinders or bottles. Very versatile.
- Drip tray.
- Gas flow control button.
- Shaped for best distribution of heat. Better performance.
- Stainless steel burner.
- Easy to handle and store.

- Cuerpo y tapa con revestimiento en poliéster siliconado.
- Soporte para encendido con fósforos.
- Conexión para cilindros o garrafas de gas. Versatilidad de uso.
- Bandeja recogedora de grasa.
- Botón de control de pérdida de gas.
- Diseño que favorece la distribución del calor. Mejor desempeño.
- Quemador de acero inoxidable.
- Facilidad para el transporte y para guardarse.



TRAMONTINA

CHURRASCO



26500/020

TGP-4700

Churrasqueira a gás

Gas grill

Grill a gas

*A= 112,2 cm

*B= 56,5 cm

*C= 138,4 cm

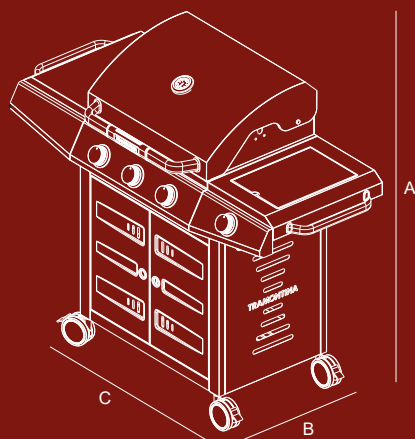



- Espaço para guardar utensílios diversos.
- Botões de controle individual dos queimadores. Acendimento automático. Não necessita de energia elétrica.
- Grelha de apoio em aço inox. Mantém seu alimento aquecido.
- Grelha e chapa em ferro fundido esmaltado. Mais robustez e maior resistência ao desgaste.
- Queimadores internos – 47 mil btus.
- Tampa articulada em aço inox com parede dupla.
- Queimador adicional para panelas.
- Bandeja coletora de gordura em aço inox.
- Medidor de temperatura interna.
- Tábua removível para corte em madeira natural.
- Tampa protetora do queimador adicional em aço inox. Área de apoio multiuso.

- Storage space for utensils.
- Individual burner knobs. Automatic ignitor. Power source not needed.
- Stainless steel grill. Keeps food warm.
- Enameled cast iron grate and griddle. Sturdy and wear resistant.
- Internal burners – 47,000 BTU grill.
- Stainless steel lid with double wall. Provides superior heat retention.
- Extra burner for pans.
- Drip tray.
- Internal temperature gauge.
- Removable cutting board in natural wood.
- Stainless steel protective burner cover. Flat area for multi-use.

- Espacio para guardar diversos utensilios.
- Botones de control individual de las hornallas. Encendido automático. No necesita energía eléctrica.
- Parrilla de carbón de acero inoxidable. Mantiene sus alimentos calientes.
- Parrilla y chapa de hierro fundido esmaltado. Más robustez y más resistencia al desgaste.
- Quemadores internos – 47 mil btus de potencia.
- Tampa articulada de acero inoxidable con pared doble. Mantiene el calor.
- Hornalla adicional para ollas.
- Bandeja recogedora de grasa.
- Medidor de temperatura interna.
- Tabla para corte retirable, de madera natural.
- Tampa protectora de la hornalla de acero inoxidable. Área de apoyo multiuso.

26500/030
TGP-4700

Capa para churrasqueira
Cover
Cubierta para grill



26500/033
TGP-4700

Grelha de ferro fundido e cobertura do queimador de aço inox
Cast iron grate and stainless steel burner cover
Parrilla de hierro fundido y cubierta del quemador de acero inoxidable

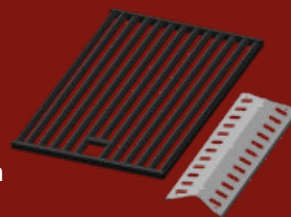

26500/034
TGP-4700

Chapa de ferro fundido
Cast iron hot plate
Chapa de hierro fundido

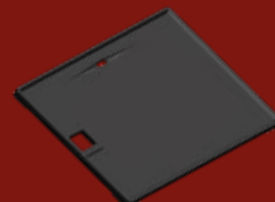

TRAMONTINA

CHURRASCO





- Alças laterais.
Maior mobilidade.
- Side handles.
Greater mobility.
- Asas laterales.
Más movilidad.



- Alça com proteção em silicone.
- Silicone protected handle.
- Asa con protección de silicona.



- Rodas de alta resistência com travas.
- Durable locking wheels.
- Ruedas de alta resistencia con trabas.



- Botões de controle individual dos queimadores.
- Individual burner knobs.
- Botones de control individual de las hornallas.

26500/032 TGP-4700

Suporte para espetos e cobertura do queimador de aço inox
Skewer holder and stainless steel burner cover
Soporte para pinchos y cubierta del quemador de acero inoxidable



TRAMONTINA

CHURRASCO



- 21199/464
- 21199/764
- 21199/964

(5")
Display de facas para churrasco 60 pçs.
60 pcs. Steak knives display
Display cuchillos asado 60 pzas.

Conteúdo | Contents | Contenido:
60 - 21100/0**
* Peças sem bainha
* Sheath not included
* Piezas sin vaina



- 21198/418
- 21198/718
- 21198/918

Display de garfos de mesa 60 pçs.
60 pcs. Table forks display
Display tenedores de mesa 60 pzas.

Conteúdo | Contents | Contenido:
60 - 21102/0**
* Peças sem bainha
* Sheath not included
* Piezas sin vaina



- 21199/449
- 21199/749
- 21199/949

(5")
Display de facas para churrasco jumbo 48 pçs.
48 pcs. Jumbo steak knives display
Display cuchillos asado jumbo 48 pzas.

Conteúdo | Contents | Contenido:
48 - 21116/0**



- 21199/468
- 21199/768
- 21199/968

(5")
Display de facas para churrasco jumbo 48 pçs.
48 pcs. Jumbo steak knives display
Display cuchillos asado jumbo 48 pzas.

Conteúdo | Contents | Contenido:
48 - 21115/0**



- 21499/406
- 21499/706
- 21499/906

(5")
Display de facas para churrasco jumbo 48 pçs.
48 pcs. Jumbo steak knives display
Display cuchillos asado jumbo 48 pzas.

Conteúdo | Contents | Contenido:
48 - 21413/0**



- 21199/469
- 21199/769
- 21199/969

Display de garfos jumbo 48 pçs.
48 pcs. Jumbo forks display
Display tenedores jumbo 48 pzas.

Conteúdo | Contents | Contenido:
48 - 21136/0**



TRAMONTINA

CHURRASCO



■ 21109/044

■ 21109/074

■ 21109/094

(4")

Faca para churrasco

Steak knife

Cuchillo chuletero

* Caixa 12 pçs. | 12pcs./pzas. boxed.



■ 21115/045

■ 21115/075

■ 21115/095

(5")

Faca para churrasco jumbo

Jumbo steak knife

Cuchillo para asado jumbo

* Caixa 12 pçs. | 12pcs./pzas. boxed.





- 21116/045
- 21116/075
- 21116/095

(5")
 Faca para churrasco jumbo
 Jumbo steak knife
 Cuchillo para asado jumbo
 * Caixa 12 pçs. | 12pcs./pzas. boxed.



- 21410/045
- 21410/075
- 21410/095

(5")
 Faca para churrasco jumbo
 Jumbo steak knife
 Cuchillo para asado jumbo
 * Caixa 12 pçs. | 12pcs./pzas. boxed.



- 21413/045
- 21413/075
- 21413/095

(5")
 Faca para churrasco jumbo
 Jumbo steak knife
 Cuchillo para asado jumbo
 * Caixa 12 pçs. | 12pcs./pzas. boxed.



- 21414/045
- 21414/075
- 21414/095

(5")
 Faca para churrasco jumbo
 Jumbo steak knife
 Cuchillo para asado jumbo
 * Caixa 12 pçs. | 12pcs./pzas. boxed.



- 21415/045
- 21415/075
- 21415/095

(5")
 Faca para churrasco jumbo
 Jumbo steak knife
 Cuchillo para asado jumbo
 * Caixa 12 pçs. | 12pcs./pzas. boxed.



- 21416/045
- 21416/075
- 21416/095

(5")
 Faca para churrasco jumbo
 Jumbo steak knife
 Cuchillo para asado jumbo
 * Caixa 12 pçs. | 12pcs./pzas. boxed.



* Caixa 12 pçs. | 12pcs./pzas. boxed.

TRAMONTINA

CHURRASCO



- 21110/040
- 21110/070
- 21110/090

Garfo de mesa - cabo longo 20,7cm
Table fork - long handle
Tenedor de mesa - mango largo
*Caixa 12 pçs. | 12pcs./pzas. boxed.



- 21136/040
- 21136/070
- 21136/090

Garfo jumbo 21,5cm
Jumbo fork
Tenedor jumbo
*Caixa 12 pçs. | 12pcs./pzas. boxed.



- 21418/044
- 21418/074
- 21418/094

(4")
Faca para churrasco
Steak knife
Cuchillo asado
*Caixa 12 pçs. | 12pcs./pzas. boxed.



- 21419/044
- 21419/074
- 21419/094

(4")
Faca para churrasco
Steak knife
Cuchillo asado
*Caixa 12 pçs. | 12pcs./pzas. boxed.



- 21435/040
- 21435/070
- 21435/090

Garfo de mesa
Table fork
Tenedor de mesa
*Caixa 12 pçs. | 12pcs./pzas. boxed.

NEW



- 21199/403
- 21199/703
- 21199/903

Jogo de talheres 12 pçs.
12 pcs. Tableware set
Juego de cubiertos 12 pzas.

Conteúdo | Contents | Contenido:

6- Facas para churrasco 5" / 5" Steak knives / Cuchillos asado 5"
6- Garfos de mesa / Table forks / Tenedores mesa



- 21199/409
- 21199/709
- 21199/909

Jogo de talheres 12 pçs.
12 pcs. Tableware set
Juego de cubiertos 12 pzas.

Conteúdo | Contents | Contenido:

6- Facas para churrasco 4" / 4" Steak knives / Cuchillos asado 4"
6- Garfos de mesa / Table forks / Tenedores mesa



Resistente à máquina de lavar
Dishwasher safe
Resistente al lavavajillas



5 anos de garantia
5 years warranty
5 años de garantía



Resistente a impactos
Impact-resistant
Resistente a impactos



Resistente a altas temperaturas
High temperature resistant
Resistente a altas temperaturas



Madeira tratada
Cured Wood
Madera tratada

TRAMONTINA

CHURRASCO



- 21198/415
- 21198/715
- 21198/915

Conjunto de facas para churrasco 6 pçs.
6 pcs. Steak knife set
Juego de cuchillos para asado 6 pzas.

Conteúdo | Contents | Contenido:
6- Facas para churrasco 5"
5" Steak knives / Cuchillos asado 5"



- 21198/416
- 21198/716
- 21198/916

Conjunto de garfos 6 pçs.
6 pcs. Fork set
Juego de tenedores 6 pzas.

Conteúdo | Contents | Contenido:
6- Garfos de mesa / Table forks /
Tenedores mesa



- 21109/644
- 21109/674
- 21109/694

Conjunto de facas para churrasco 6 pçs.
6 pcs. Steak knife set
Juego de cuchillos chuletero 6 pzas

Conteúdo | Contents | Contenido:
6- Facas para churrasco 4"
4" Steak knives / Cuchillos chuletero 4"



- 21413/645
- 21413/675
- 21413/695

Conjunto de facas jumbo 6 pçs.
6 pcs. Jumbo knife set
Juego de cuchillos jumbo 6 pzas.

Conteúdo | Contents | Contenido:
6- Facas para churrasco jumbo 5"
5" Jumbo steak knives /
Cuchillos asado jumbo 5"



- 21110/640
- 21110/670
- 21110/690

Conjunto de garfos 6 pçs.
6 pcs. Fork set
Juego de tenedores 6 pzas.

Conteúdo | Contents | Contenido:
6- Garfos de mesa / Table forks /
Tenedores mesa



- 21199/411
- 21199/711
- 21199/911

Jogo de talheres 12 pçs.
12 pcs. Tableware set
Juego de cubiertos 12 pzas.

Conteúdo | Contents | Contenido:
6- Facas para churrasco 5"/ 5" Steak
knives / Cuchillos asado 5"
6- Garfos de mesa / Table forks /
Tenedores mesa



- 21199/431
- 21199/731
- 21199/931

Conjunto de facas para churrasco jumbo 4 pçs.
4 pcs. Jumbo steak knives set
Conjunto cuchillos asado jumbo 4 pzas.

Conteúdo | Contents | Contenido:
4- Facas para churrasco jumbo 5" / 5" Jumbo steak knives /
Cuchillos asado jumbo 5"



- 21198/417
- 21198/717
- 21198/917

Conjunto de facas para churrasco jumbo 4 pçs.
4 pcs. Jumbo steak knives set
Juego de cuchillos para asado jumbo 4 pzas.

Conteúdo | Contents | Contenido:
4- Facas para churrasco jumbo 5" / 5" Jumbo steak knives /
Cuchillos asado jumbo 5"



- 21198/408
- 21198/708
- 21198/908

Jogo de talheres jumbo 4 pçs.
4 pcs. Jumbo tableware set
Juego de cubiertos jumbo 4 pzas.

Conteúdo | Contents | Contenido:
2- Facas para churrasco jumbo 5" / 5" Jumbo
steak knives / Cuchillo asado jumbo 5"
2- Garfos jumbo / Jumbo fork / Tenedores jumbo

TRAMONTINA

CHURRASCO



- 21199/489
- 21199/789
- 21199/989

Kit para churrasco 14 pçs.
14 pcs. Barbecue set
Juego para asado 14 pzas.

Conteúdo | Contents | Contenido:
6- Facas para churrasco 5" / 5" Steak knives /
Cuchillos asado 5"
6- Garfos de mesa / Table forks / Tenedores mesa
1- Faca para carne 8" / 8" Cook's knife / Cuchillo cocina 8"
1- Garfo trinchante / Carving fork / Tenedor trinchante



- 21199/497
- 21199/797
- 21199/997

Conjunto de garfos jumbo 4 pçs.
4 pcs. Jumbo forks set
Juego de tenedores jumbo 4 pzas.

Conteúdo | Contents | Contenido:
4- Garfos jumbo / Jumbo fork / Tenedores jumbo



- 21199/496
- 21199/796
- 21199/996

Jogo de talheres jumbo 12 pçs.
12 pcs. Jumbo tableware set
Juego de cubiertos jumbo 12 pzas.

Conteúdo | Contents | Contenido:
6- Facas para churrasco jumbo 5" / 5" Jumbo steak
knives / Cuchillos jumbo asado 5"
6- Garfos jumbo / Jumbo forks / Tenedores jumbo



- 21199/486
- 21199/786
- 21199/986

Display de talheres 140 pçs.
140pcs. Tableware set
Display cubiertos 140 pzas.

Conteúdo | Contents | Contenido:
70- Facas para churrasco 5" / 5" Steak knives / Cuchillos asado 5"
70- Garfos de mesa / Table forks / Tenedores mesa



TRAMONTINA

CHURRASCO



■ 21199/495

■ 21199/795

■ 21199/995

Jogo para churrasco 2 pçs.

2 pcs. Barbecue set

Juego para asado 2 pzas.

Conteúdo | Contents | Contenido:

1- Faca para carne 8" com bainha / 8" Meat knife with sheath / Cuchillo para carne 8" con vaina

1- Chaira 8" / 8" Sharpener / Afilador 8"



■ 21199/422

■ 21199/722

■ 21199/922

(10")
Faca para carne
Meat knife
Cuchillo carne



■ 21141/148

■ 21141/178

■ 21141/198

(8")
Faca para carne com bainha
Meat knife with sheath
Cuchillo carne con vaina



■ 26080/147

■ 26080/177

■ 26080/197

(7")
Faca para carne com bainha
Meat knife with sheath
Cuchillo carne con vaina



EXTREME





The mark of responsible forestry



26580/108 - 50,2 cm
Faca trinchante 8"
8" Carving knife
Cuchillo trinchante 8"



26581/100 - 47,1 cm
Garfo trinchante
Carving fork
Tenedor trinchante



26582/100 - 47,8 cm
Espátula multifuncional
Multipurpose spatula
Espátula multifuncional



26583/100 - 47,3 cm
Pegador para carne
Meat tong
Pinza Carne



26584/100 - 44,3 cm
Escova para grelhas
Grill brush
Cepillo para parrillas



26585/100 - 41,8 cm
Pincel
Brush
Pincel



26599/001
Jogo de utensílios 3 pçs.
3 pcs. Utensils set
Juego de utensílios 3 pzas.

Conteúdo | Contents | Contenido:
1- Faca trinchante 8" / 8" Carving knife /
Cuchillo trinchante 8" - 50,2 cm
1- Garfo trinchante / Carving fork /
Tenedor trinchante - 47,1 cm
1- Pegador para carne / Meat tong /
Pinza carne - 47,3 cm

★★★★★
EXTREME

TRAMONTINA

CHURRASCO

FACAS FORJADAS FORGED KNIVES I CUCHILLOS FORJADOS



FILO
LISO
SMOOTH EDGE
FILO LISO

- 21570/045 (5") Faca para churrasco jumbo
- 21570/075 Jumbo steak knife
- 21570/095 Cuchillo asado jumbo

- 21571/045 (5") Faca para churrasco jumbo
- 21571/075 Jumbo steak knife
- 21571/095 Cuchillo asado jumbo



FILO
SERRILHADO
SERRATED EDGE
FILO CON DIENTES

- 21572/040 Garfo jumbo
- 21572/070 Jumbo fork
- 21572/090 Tenedor jumbo



- 21573/047 (7") Faca para carne
- 21573/077 Meat knife
- 21573/097 Cuchillo carne



- 21574/048 (8") Faca para carne
- 21574/078 Meat knife
- 21574/098 Cuchillo carne



- 21575/048 (8") Faca para carne
- 21575/078 Meat knife
- 21575/098 Cuchillo carne



- 21576/040 Garfo trinchante
- 21576/070 Carving fork
- 21576/090 Tenedor trinchante



★ ★ ★ ★ ★
EXTREME

- 21575/148
- 21575/178
- 21575/198



(8")
 Faca para carne com bainha
 Meat knife with sheath
 Cuchillo carne con vaina

- 21599/459
- 21599/759
- 21599/959



Jogo trinchante 3 pçs.
 3 pcs. Cutlery set
 Juego cuchillos 3 pzas.

Conteúdo | Contents | Contenido:

- 1- Faca para carne 8" / 8" Meat knife / Cuchillo carne 8"
- 1- Garfo trinchante / Carving fork / Tenedor trinchante
- 1- Estojo sintético / Synthetic case / Estuche sintético

- 21599/458
- 21599/758
- 21599/958



Kit para churrasco 3 pçs.
 3 pcs. Barbecue set
 Juego para asado 3 pzas.

Conteúdo | Contents | Contenido:

- 1- Faca para carne 8" / 8" Meat knife / Cuchillo carne 8"
- 1- Garfo trinchante / Carving fork / Tenedor trinchante
- 1- Tábua de corte / Cutting board / Tabla de madera (42x29cm)

CHURRASCO



- 21185/045 (5")
- 21185/075 Faca para churrasco jumbo
- 21185/095 Jumbo steak knife
- 21185/095 Cuchillo asado jumbo



- 21186/040 Garfo jumbo
- 21186/070 Jumbo fork
- 21186/090 Tenedor jumbo



- 21187/140 (10")
- 21187/170 Faca para carne
- 21187/190 Meat knife
- 21187/190 Cuchillo carne



- 21188/146 (6")
- 21188/176 Faca para desossar
- 21188/196 Boning knife
- 21188/196 Cuchillo deshuesar



- 21189/148 (8")
- 21189/178 Faca para carne
- 21189/198 Meat knife
- 21189/198 Cuchillo carne



- 21190/148 (8")
- 21190/178 Faca para carne
- 21190/198 Meat knife
- 21190/198 Cuchillo carne



- 21191/148 (8")
- 21191/178 Faca para carne
- 21191/198 Meat knife
- 21191/198 Cuchillo carne



- 21192/140 Garfo trinchante
- 21192/170 Carving fork
- 21192/190 Tenedor trinchante



- 21193/148 (8")
- 21193/178 Chaira
- 21193/198 Sharpener
- 21193/198 Afilador



- 21189/048 (8")
- 21189/078 Faca para carne com bainha
- 21189/098 Meat knife with sheath
- 21189/098 Cuchillo carne con vaina



TRAMONTINA

CHURRASCO



- 21190/048 (8")
 - 21190/078
 - 21190/098
- Faca para carne com bainha
Meat knife with sheath
Cuchillo carne con vaina



- 21191/048 (8")
 - 21191/078
 - 21191/098
- Faca para carne com bainha
Meat knife with sheath
Cuchillo carne con vaina



- 21198/459
- 21198/759
- 21198/959

Jogo de talheres jumbo 8 pçs.
8 pcs. Jumbo tableware set
Juego de cubiertos jumbo 8 pzas

Conteúdo | Contents | Contenido:
4- Faca para churrasco jumbo 5"/5" Jumbo
Steak knives / Cuchillo asado 5" jumbo
4- Garfos jumbo / Jumbo forks / Tenedores jumbo

- 21198/460
- 21198/760
- 21198/960

Jogo trinçante 2 pçs.
2 pcs. Barbecue set
Juego para asado 2 pzas.

Conteúdo | Contents | Contenido:

1- Faca para carne 8"/8" Meat knife / Cuchillo asado 8"
1- Garfos trinçante / Carving fork / Tenedor trinçante





- 21169/140 Pegador para carne (37cm)
- 21169/170 Meat tong (37cm)
- 21169/190 Pinza carne (37cm)



- 21174/140
- 21174/141
- 21174/170 Pegador para carne (37cm - 47cm)
- 21174/171 Meat tong (37cm - 47cm)
- 21174/171 Pinza carne (37cm - 47cm)
- 21174/190
- 21174/191



- 21175/140 Pegador para carne (37cm)
- 21175/170 Meat tong (37cm)
- 21175/190 Pinza carne (37cm)



- 21198/461 Jogo para churrasco 3 pçs.
 - 21198/761 3 pcs. Barbecue set
 - 21198/961 Juego para asado 3 pzas.
- Conteúdo | Contents | Contenido:
- 1- Pegador para carne / Meat tong / Pinza carne -37cm
 - 1- Faca para carne 8" / 8" Meat knife / Cuchillo carne 8"
 - 1- Garfo trinchante / Carving fork / Tenedor trinchante



- 21198/463
 - 21198/763
 - 21198/963
- Kit para churrasco 4 pçs.
4 pcs. Barbecue set
Juego para asado 4 pzas.
- Conteúdo | Contents | Contenido:
- 1- Faca para carne 8" / 8" Meat knife / Cuchillo carne 8"
 - 1- Garfo trinchante / Carving fork / Tenedor trinchante
 - 1- Chaira 8" / 8" Sharpener / Afilador 8"
 - 1- Tábua de madeira / Cutting board / Tabla de madera (40x29,5cm)

CHURRASCO



- 21198/462 Kit para churrasco 3 pçs.
- 21198/762 3 pcs. Barbecue set
- 21198/962 Juego para asado 3 pzas.

Conteúdo | Contents | Contenido:

- 1- Faca para carne 8" / 8" Meat knife / Cuchillo carne 8"
- 1- Garfo trinchante / Carving fork / Tenedor trinchante
- 1- Tábua de madeira / Cutting board / Tabla de madera (37x24cm)



- 21198/414
- 21198/714
- 21198/914

Jogo para churrasco 3 pçs.
3 pcs. Barbecue set
Juego para asado 3 pzas.

Conteúdo | Contents | Contenido:

- 1- Faca para carne 8" / 8" Meat knife / Cuchillo carne 8"
- 1- Garfo trinchante / Carving fork / Tenedor trinchante
- 1- Tábua de madeira / Cutting board / Tabla de madera (40x23cm)



- 21198/464
- 21198/764
- 21198/964

Kit para churrasco 4 pçs.
4 pcs. Barbecue set
Juego para asado 4 pzas.

Conteúdo | Contents | Contenido:

- 1- Faca para carne 8" / 8" Meat knife / Cuchillo carne 8"
- 1- Garfo trinchante / Carving fork / Tenedor trinchante
- 1- Chaira 8" / 8" Sharpener / Afilador 8"
- 1- Estojo de madeira / Wooden case / Maleta de madera

- 21198/465
- 21198/765
- 21198/965

Kit para churrasco 8 pçs.
8 pcs. Barbecue set
Juego para asado 8 pzas.

Conteúdo | Contents | Contenido:

- 1- Pegador para carne / Meat tong / Pinza carne - 37cm
- 1- Faca para desossar 6" 6" Boning knife / Cuchillo deshuesar 6"
- 1- Faca para carne 8" / 8" Meat knife / Cuchillo carne 8"
- 1- Faca para carne 8" / 8" Meat knife / Cuchillo carne 8"
- 1- Garfo trinchante / Carving fork / Tenedor trinchante
- 1- Chaira 8" / 8" Sharpener / Afilador 8"
- 1- Tábua de madeira / Cutting board / Tabla de madera (37x23cm)
- 1- Estojo sintético / Synthetic case / Estuche sintético



■ 21198/466

■ 21198/766

■ 21198/966

Kit para churrasco 17 pçs.
17 pcs. Barbecue set
Juego para asado 17 pzas.

Conteúdo | Contents | Contenido:

6- Facas para churrasco jumbo 5" / 5" Jumbo steak knives /
Cuchillos asado 5" jumbo

6- Garfos jumbo / Jumbo forks / Tenedores jumbo

1- Pegador para carne / Meat tong / Pinza carne -37cm

1- Faca para carne 10" / 10" Meat knife / Cuchillo carne 10"

1- Garfo trinchante / Carving fork / Tenedor trinchante

1- Tábua de madeira / Cutting board / Tabla de madera

1- Maleta de madeira / Wooden case / Maleta de madera (45x28cm)



TRAMONTINA

CHURRASCO



TRAMONTINA
MADE IN BRAZIL



■ 21198/468

■ 21198/768

■ 21198/968

Jogo para churrasco 5 pçs.
5 pcs. Barbecue set
Juego para asado 5 pzas.

Conteúdo | Contents | Contenido:

1- Faca para carne 8" / 8" Meat knife / Cuchillo carne 8"

1- Faca para carne 8" / 8" Meat knife / Cuchillo carne 8"

1- Faca para carne 8" / 8" Meat knife / Cuchillo carne 8"

1- Chaira 8" / 8" Sharpener / Afilador 8"

1- Suporte de madeira / Wooden knives storage / Taco madera

TRAMONTINA

CHURRASCO



Todas as informações sobre as medidas estão considerando os cabos.

All the informations about measures are considering together with the handles.

Todas las informaciones sobre las medidas están considerando mangos juntos.



26417/055 - 55 cm
26417/065 - 65 cm
26417/075 - 75 cm
26417/085 - 85 cm

Espeto
Skewer
Pincho para asado



26418/065 - 65 cm
26418/075 - 75 cm
26418/085 - 85 cm
26418/095 - 95 cm
26418/105 - 105 cm

Espeto
Skewer
Pincho para asado



26419/065 - 65 cm
26419/075 - 75 cm
26419/085 - 85 cm
26419/095 - 95 cm

Espeto
Skewer
Pincho para asado



26433/055 - 55 cm
26433/065 - 65 cm
26433/075 - 75 cm
26433/085 - 85 cm

Espeto
Skewer
Pincho para asado



26434/065 - 65 cm
26434/075 - 75 cm
26434/085 - 85 cm
26434/095 - 95 cm

Espeto
Skewer
Pincho para asado

TRAMONTINA

CHURRASCO



26475/085 - 85 cm

26475/095 - 95 cm

Espeto
Skewer
Pincho para asado



26476/085 - 85 cm

26476/095 - 95 cm

26476/105 - 105 cm

Espeto
Skewer
Pincho para asado



26499/002 - 20 cm

26499/003 - 30 cm

Conjunto de espetinhos 6 pçs.
6 pcs Skewers set
Juego de pinchos 6 pzas.



26499/005 - 40 cm

26499/006 - 50 cm

Conjunto de espetinhos 6 pçs.
6 pcs Skewers set
Juego de pinchos 6 pzas.



26499/009 - 40 cm

Conjunto de espetinhos 6 pçs.
6 pcs Skewers set
Juego de pinchos 6 pzas.



26499/011 - 50 cm

26499/012 - 60 cm

Conjunto de espetinhos 6 pçs.
6 pcs Skewers set
Juego de pinchos 6 pzas.



26469/100 - 37 cm
Pá para cinzas
Ash Shovel
Pala para cenizas

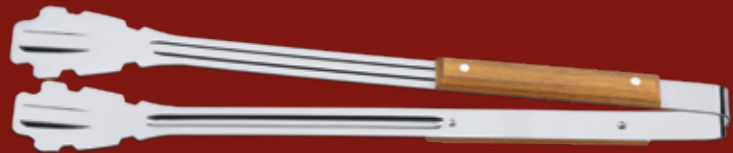

26467/100 - 47 cm
Pegador para carvão
Charcoal tong
Pinza para carbón



26468/100
Puxador para brasa
Charcoal rake
Rastrillo para carbón



26470/075
Pá para cinzas
Ash Shovel
Pala de cenizas



26471/075
Mexedor de brasa
Coal scraper
Atizador de brasas

TRAMONTINA

CHURRASCO





26441/100 - 48 cm
Espátula
Spatula
Espátula



26442/100 - 48 cm
Espátula multifuncional
Multipurpose spatula
Espátula multifuncional



26443/100 - 46 cm
Garfo trinchante
Carving fork
Tenedor trinchante



26444/107 - 45,8 cm
(7")
Faca trinchante
Carving knife
Cuchillo trinchante



26440/108 - 47,6 cm
(8")
Faca trinchante
Carving knife
Cuchillo trinchante



26445/100 - 41,6 cm
Escova
Grill brush
Cepillo para limpiar



26446/100 - 37 cm
Pegador para carne
Meat tong
Pinza carne



26400/100 - 37 cm / 101 - 47 cm
Pegador para carne
Meat tong
Pinza carne

TRAMONTINA

CHURRASCO



26499/026

Kit para churrasco 6 pçs.
6 pcs. Barbecue set
Juego para asado 6 pzas.

Conteúdo | Contents | Contenido:

3- Espetos 65cm / Skewer/
Pincho para asado 65cm
1- Faca trinchante 7" / 7" Carving knife/Cuchillo
trinchante 7"
1- Garfo trinchante / Carving fork / Tenedor trinchante
1- Pegador para carne / Meat tong /
Pinza carne



26499/032

Kit para churrasco 6 pçs.
6 pcs. Barbecue set
Juego para asado 6 pzas.

1- Faca para carne 8" / 8" Meat knife / Cuchillo carne 8"
1- Garfo trinchante / Carving fork / Tenedor trinchante
2- Espetos Largos / Skewer / Pincho para asado
2- Espetos Estreitos / Skewer / Pincho para asado



26499/034

Jogo trinchante 2 pçs.
2 pcs. Carving set
Juego trinchante 2 pzas.

Conteúdo | Contents | Contenido:

1- Faca trinchante 8" / 8" Carving knife / Cuchillo
trinchante 8"
1- Garfo trinchante / Carving fork / Tenedor trinchante



26499/035

Jogo para churrasco 3 pçs.
3 pcs. Barbecue set
Juego para asado 3 pzas.

Conteúdo | Contents | Contenido:

1- Faca trinchante 8" / 8" Carving knife / Cuchillo
trinchante 8"
1- Garfo trinchante / Carving fork / Tenedor trinchante
1- Espátula / Spatula / Espátula



26499/036

Kit para churrasco 3 pçs.
3 pcs. Barbecue set
Juego para asado 3 pzas.

Conteúdo | Contents | Contenido:

1- Faca trinchante 7" / 7" Carving knife / Cuchillo
trinchante 7"
1- Garfo trinchante / Carving fork / Tenedor trinchante
1- Pegador para carne / Meat tong / Pinza carne



26499/037

**Jogo trinçante 2 pçs.
2 pcs. Carving set
Juego trinçante 2 pzas.**

Conteúdo | Contents | Contenido:
1- Faca trinçante 7"/ 7" Carving knife /
Cuchillo trinçante 7"
1- Garfo trinçante / Carving fork / Tenedor trinçante



26499/044

**Jogo trinçante 2 pçs.
2 pcs. Carving set
Juego trinçante 2 pzas.**

Conteúdo | Contents | Contenido:
1- Faca trinçante 9"/ 9" Carving knife /
Cuchillo trinçante 9"
1- Garfo trinçante / Carving fork / Tenedor trinçante



26499/045

**Jogo de utensílios 3 pçs.
3 pzas. Utensils set
Juego de utensílios 3 pzas.**

Conteúdo | Contents | Contenido:
1- Faca trinçante 8"/ 8" Carving knife /
Cuchillo trinçante 8"
1- Garfo trinçante / Carving fork / Tenedor trinçante
1- Pegador para carne / Meat tong / Pinza carne



26499/046

**Descrição correta:
Jogo trinçante 2 pçs.
2 pcs. Carving set
Juego trinçante 2 pzas.**

Conteúdo | Contents | Contenido:
1- Faca trinçante 8"/ 8" Carving knife /
Cuchillo trinçante 8"
1- Garfo trinçante / Carving fork / Tenedor trinçante



24699/825

**Jogo de facas 4 pçs.
4 pcs. knives set
Juego de cuchillos 4 pzas.**

Conteúdo | Contents | Contenido:
1- Faca para desossar 5"/ 5" Boning knife/
Cuchillo deshuesar 5"
1- Faca para carne 8"/ 8" Meat knife / Cuchillo carne 8"
1- Faca para carne 8"/ 8" Meat knife / Cuchillo carne 8"
1- Chaira 8"/ 8" Sharpener / Afilador 8"

TRAMONTINA

CHURRASCO



26466/100
Avental
Apron
Delantal



26499/042
Moedor de sal e pimenta
Salt and pepper grinders
Moladores de sal y pimienta



26459/100
Saleiro
Salt shaker
Salero



26460/100 - 21,6 cm
Escova
Grill brush
Cepillo para limpiar



26461/100 - 44 cm
Escova
Grill brush
Cepillo para limpiar



26462/100
Injetor para temperos 30ml
Marinade injector 30ml
Jeringa para inyectar adobo 30 ml



26479/100
Soprador manual
Charcoal blower
Soprador para el carbón



26463/100
Luva para Churrasco
Barbecue Mitt
Guante para asado



26464/100 - 55cm
Barra magnética para facas
Magnetic knife rack
Barra magnética para cuchillos



TRAMONTINA

CHURRASCO



22399/037

Kit para churrasco 10 pçs.
10 pcs. Barbecue set
Juego para asado 10 pzas.

Conteúdo | Contents | Contenido:

- 4- Facas para churrasco jumbo 5"/5" Jumbo steak knives / Cuchillos asado jumbo 5"
- 4- Garfos jumbo / Jumbo forks / Tenedores jumbo
- 1- Garfo trinchante / Carving fork / Tenedor trinchante
- 1- Faca para carne 8"/8" Carving knife / Cuchillo trinchante 8"



26499/039

Kit para churrasco 17 pçs.
17 pcs. Barbecue set
Juego para asado 17 pzas.

Conteúdo | Contents | Contenido:

- 6- Facas para churrasco jumbo 5"/5" Jumbo steak knives / Cuchillos asado jumbo 5"
- 6- Garfos jumbo / Jumbo forks / Tenedores jumbo
- 1- Pegador para carne / Meat tong / Pinza carne
- 1- Espátula multifuncional / Multipurpose spatula / Espátula multifuncional
- 1- Garfo trinchante / Carving fork / Tenedor trinchante
- 1- Faca trinchante 7"/7" Carving knife / Cuchillo trinchante 7"
- 1- Maleta de madeira / Wooden case / Maleta de madera



26499/040

Kit para churrasco 6 pçs.
6 pcs. Barbecue set
Juego para asado 6 pzas.

Conteúdo | Contents | Contenido:

- 1- Espátula multifuncional / Multipurpose spatula / Espátula multifuncional
- 1- Garfo trinchante / Carving fork / Tenedor trinchante
- 1- Faca trinchante 7"/7" Carving knife / Cuchillo trinchante 7"
- 1- Escova / Grill brush / Cepillo para limpiar
- 1- Pegador para carne / Meat tong / Pinza carne
- 1- Avental / Apron / Delantal



22299/009

Jogo de talheres 12 pçs.
12 pcs. Tableware set
Juego de cubiertos 12 pzas.

Conteúdo | Contents | Contenido:

6- Facas para churrasco 5" / 5" Steak knives /
Cuchillos asado 5"
6- Garfos mesa / Table forks / Tenedores mesa



22299/002

Jogo de talheres 12 pçs.
12 pcs. Tableware set
Juego de cubiertos 12 pzas.

Conteúdo | Contents | Contenido:

6- Facas para churrasco 5" / 5" Steak knives /
Cuchillos asado 5"
6- Garfos mesa / Table forks / Tenedores mesa



22299/011

Kit para churrasco 14 pçs.
14 pcs. Barbecue set
Juego para asado 14 pzas.

Conteúdo | Contents | Contenido:

6- Facas para churrasco 5" / 5" Steak knives /
Cuchillos asado 5"
6- Garfos mesa / Table forks / Tenedores mesa
1- Garfo trinchante / Carving fork / Tenedor
trinchante
1- Faca carne 7" / 7" meat knife / Cuchillo
carne 7"



22399/028

Kit para churrasco 15 pçs.
15 pcs. Barbecue set
Juego para asado 15 pzas.

Conteúdo | Contents | Contenido:

6- Facas para churrasco 5" / 5" Steak knives /
Cuchillos asado 5"
6- Garfos mesa / Table forks / Tenedores mesa
1- Garfo trinchante / Carving fork / Tenedor trinchante
1- Faca para carne 8" / 8" Meat knife / Cuchillo carne 8"
1- Pegador para carne / Meat tong / Pinza carne



TRAMONTINA

CHURRASCO



22299/012

Jogo trinchante 2 pçs.
2 pcs. Carving set
Juego trinchante 2 pzas.

Conteúdo | Contents | Contenido:

1- Faca trinchante 9" / 9" Slicer knife / Cuchillo trinchante 9"
1- Garfo trinchante / Carving fork / Tenedor trinchante



22299/013

Jogo trinchante 2 pçs.
2 pcs. Carving set
Juego trinchante 2 pzas.

Conteúdo | Contents | Contenido:

1- Faca para carne 7" / 7" Cook's knife /
Cuchillo cocina 7"
1- Garfo trinchante / Carving fork / Tenedor
trinchante



22299/055

Jogo para churrasco 3 pçs.
3 pcs. Barbecue set
Juego para asado 3 pzas.

Conteúdo | Contents | Contenido:

1- Faca para carne 7" / 7" Cook's knife /
Cuchillo cocina 7"
1- Garfo trinchante / Carving fork / Tenedor
trinchante
1- Chaira 8" / 8" Sharpener / Afilador 8"



22299/046

Kit para churrasco 3 pçs.
3 pcs. Barbecue set
Juego para asado 3 pzas.

Conteúdo | Contents | Contenido:

1- Faca para carne 7" / 7" Cook's knife / Cuchillo cocina 7"
1- Garfo trinchante / Carving fork / Tenedor trinchante
1- Tábua de madeira / Cutting board / Tabla de madera (33x20cm)



22299/047

Kit para churrasco 4 pçs.
4 pcs. Barbecue set
Juego para asado 4 pzas.

Conteúdo | Contents | Contenido:

1- Faca para carne 9" / 9" Cook's knife / Cuchillo cocina 9"
1- Chaira 8" / 8" Sharpener / Afilador 8"
1- Garfo trinchante / Carving fork / Tenedor trinchante
1- Tábua de madeira / Cutting board / Tabla de madeira (37x23cm)

GRELHAS GRILL I PARILLA

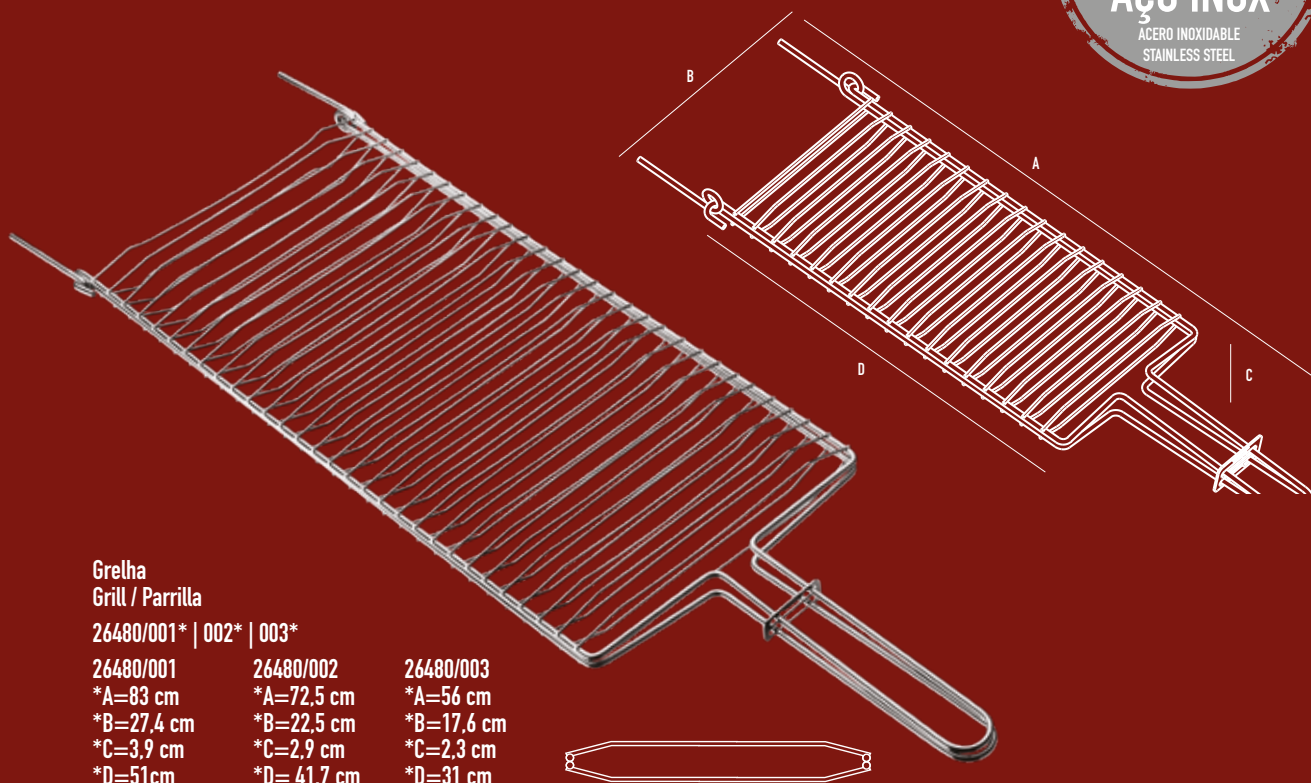

Grelha
Grill / Parrilla

26480/001* | 002* | 003*

26480/001

*A=83 cm

*B=27,4 cm

*C=3,9 cm

*D=51 cm

26480/002

*A=72,5 cm

*B=22,5 cm

*C=2,9 cm

*D=41,7 cm

26480/003

*A=56 cm

*B=17,6 cm

*C=2,3 cm

*D=31 cm



Grelha plana
Flat grill / Parrilla plana

26481/001* | 002* | 003*

26481/001

*A=83 cm

*B=27,4 cm

*C=2,8 cm

*D=51 cm

26481/002

*A=72,5 cm

*B=23,3 cm

*C=2,6 cm

*D=41,7 cm

26481/003

*A=56 cm

*B=18,5 cm

*C=2,6 cm

*D=31 cm

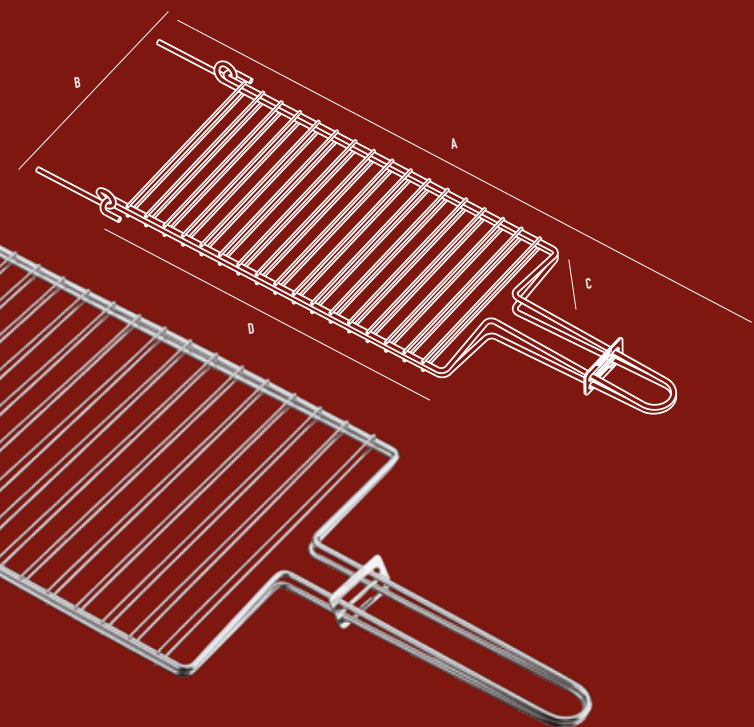

*A = Comprimento total / Total length / Longitud total

*B = Largura / Width / Ancho

*C = Altura / Height / Altura

*D = Comprimento grelha / Length scale / Longitud de la red

TRAMONTINA

CHURRASCO





Grelha com coletor de gordura
Grill with drip tray
Parrilla con reductor de grasa

26492/001*	26492/002*
*A=79,3 cm	*A=79,3 cm
*B=49 cm	*B=34 cm
*C=5,1 cm	*C=5,1 cm
*D=50 cm	*D=50 cm

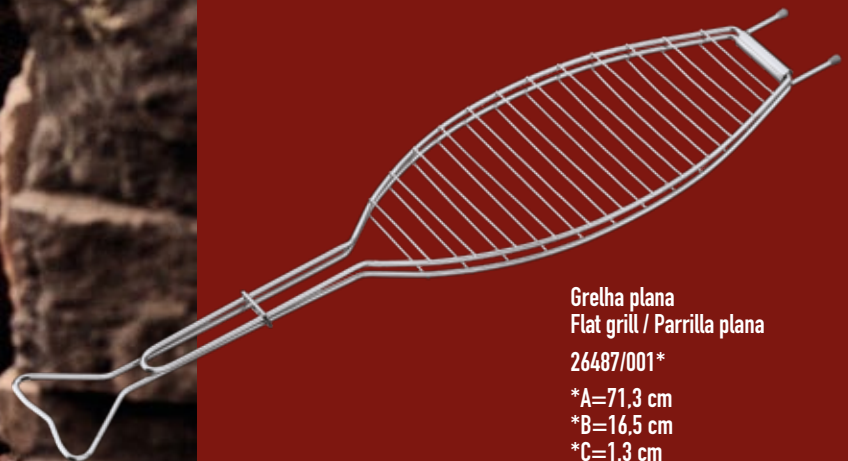

Grelha plana
Flat grill / Parrilla plana

26487/001*
*A=71,3 cm
*B=16,5 cm
*C=1,3 cm
*D=40 cm

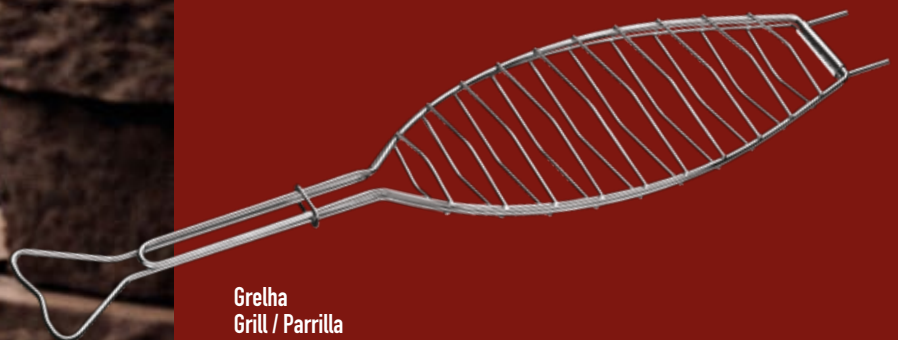

Grelha
Grill / Parrilla

26483/000*
*A=71,3 cm
*B=16,5 cm
*C=3,8 cm
*D=40 cm



TRAMONTINA

CHURRASCO

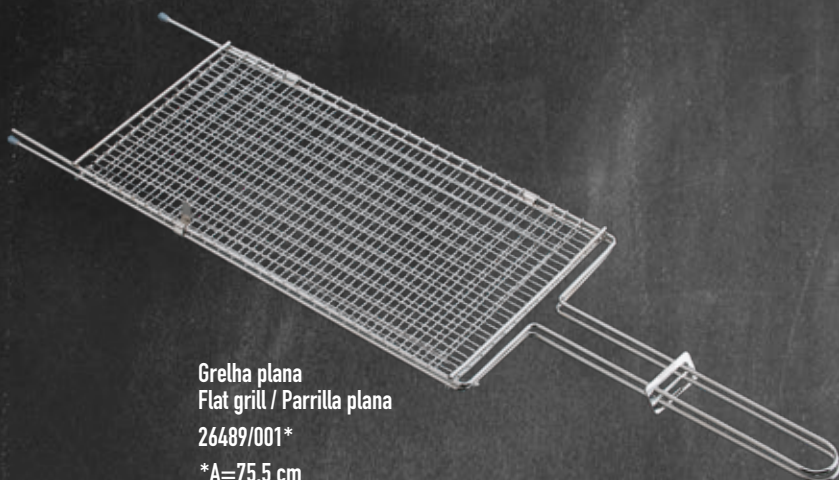

Grelha plana
Flat grill / Parrilla plana

26489/001*

*A=75,5 cm

*B=18,1 cm

*C=1,9 cm

*D=46,2 cm



Grelha plana
Flat grill / Parrilla plana

26488/001*

*A=76 cm

*B=27 cm

*C=1,9 cm

*D=42,2 cm

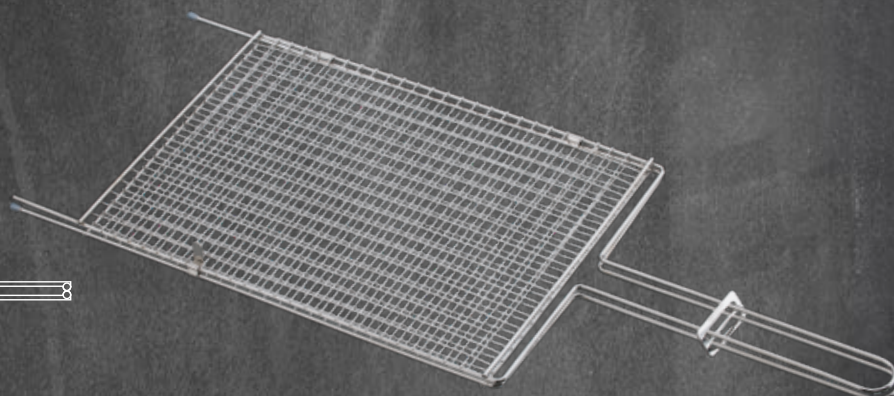
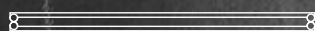

Grelha
Grill / Parrilla

26484/000*

*A=75,5 cm

*B=27 cm

*C=2,7 cm

*D=42,2 cm

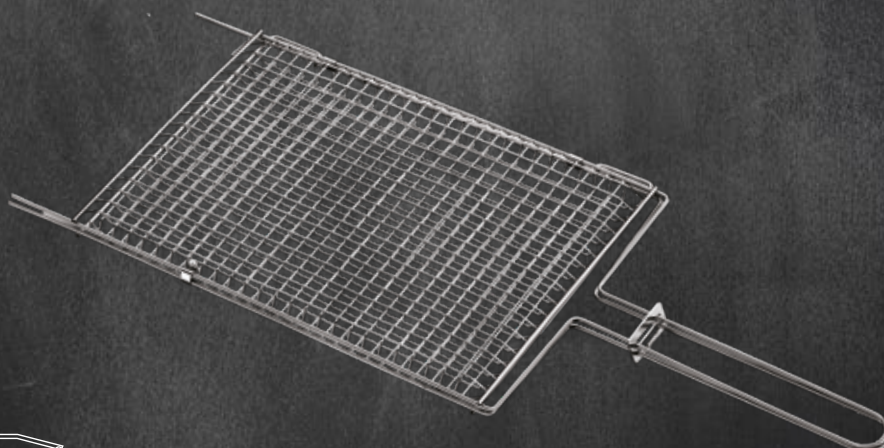

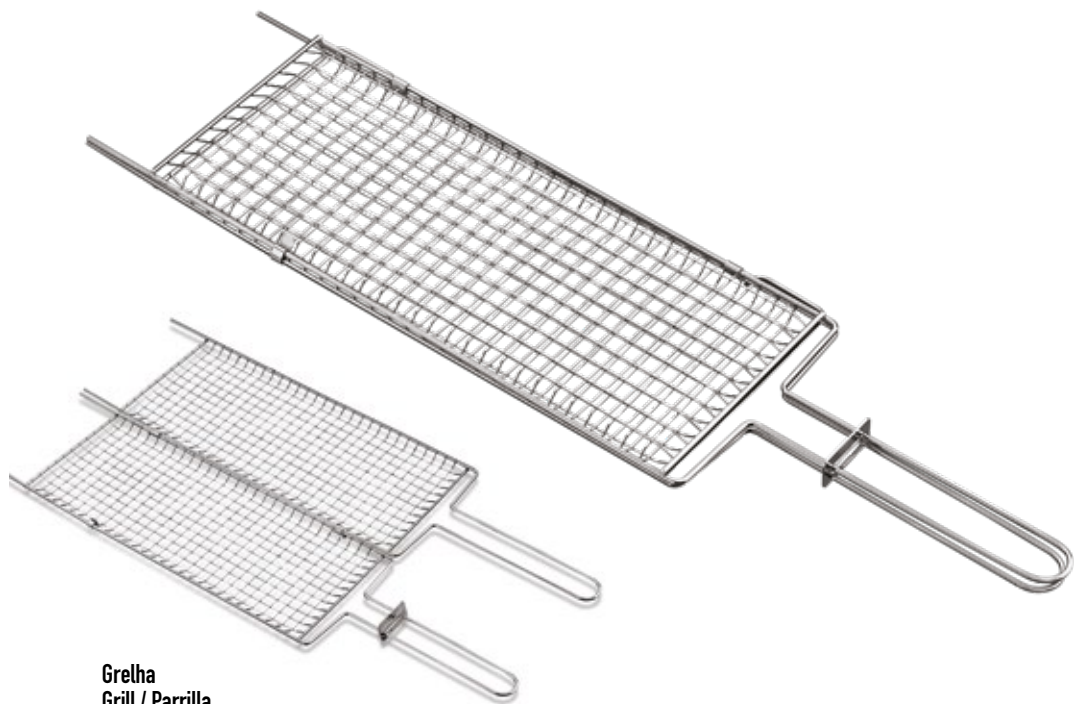

Grelha
Grill / Parrilla
26486/000*
*A=76 cm
*B=18,1 cm
*C=2,7 cm
*D=46,2 cm

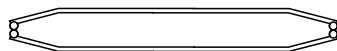

20889/030
Grelha para vegetais
Vegetable cooking grate
Parrilla para vegetables

TRAMONTINA

CHURRASCO

Grelha
Grill / Parrilla

26490/001* | 002* | 003* | 005*

26490/001

*A=83,5 cm

*B=60 cm

*C=3,2 cm

*D=50 cm

26490/002

*A=83,5 cm

*B=55 cm

*C=3,2 cm

*D=50 cm

26490/003

*A=83,5 cm

*B=45 cm

*C=3,2 cm

*D=50 cm

26490/005

*A=83,5 cm

*B=60 cm

*C=3,2 cm

*D=40 cm

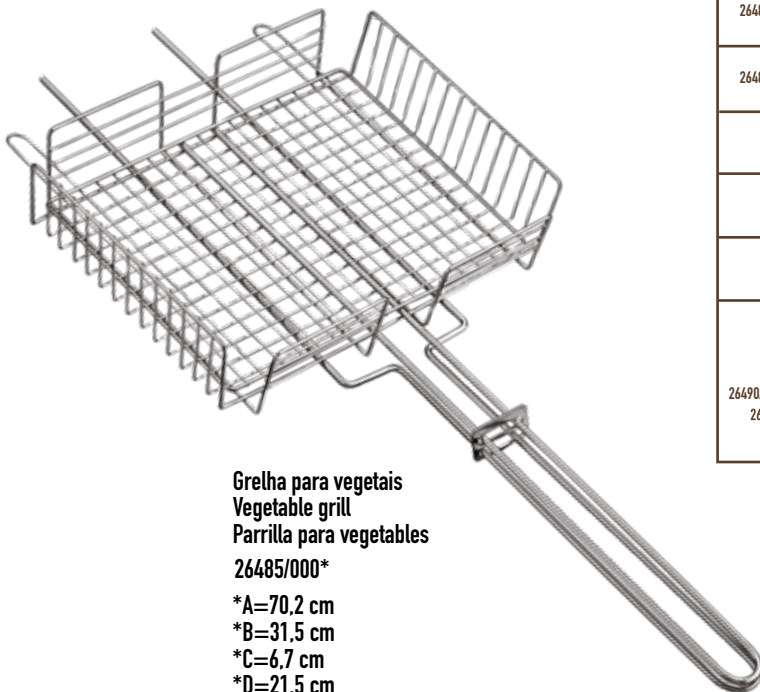

Grelha para vegetais
Vegetable grill
Parrilla para vegetables

26485/000*

*A=70,2 cm

*B=31,5 cm

*C=6,7 cm

*D=21,5 cm

Ref.	
26480/001/002/003 26484/000	
26481/001/002/003	
26483/000	
26487/001	
20889/030	
26488/001 26486/000 26489/001	
26490/001/002/003/005 26492/001/002 26485/000	

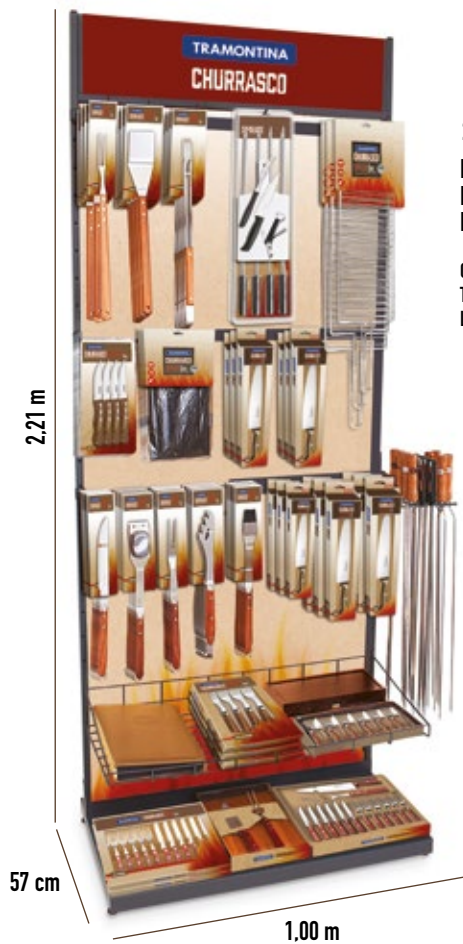

29998/027

Display autoportante
Freestanding wall display
Exhibidor pared autoportante

Os produtos são meramente ilustrativos.
The products are for illustration purposes only.
Los productos que se muestran son a modo ilustrativo.

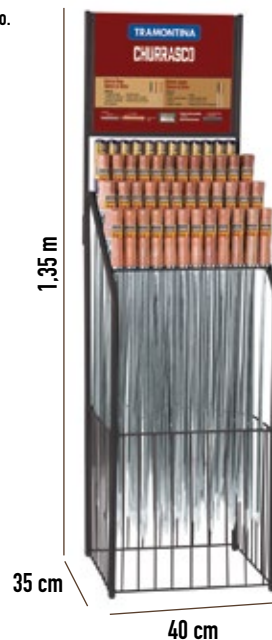

29998/031

Expositor para espetos
Skewer Display Rack
Expositor de espiedos

Os produtos são meramente ilustrativos.
The products are for illustration purposes only.
Los productos que se muestran son a modo ilustrativo.



29998/035

Display autoportante
Freestanding wall display
Exhibidor pared autoportante

Os produtos são meramente ilustrativos.
The products are for illustration purposes only.
Los productos que se muestran son a modo ilustrativo.



29998/036

Display autoportante
Freestanding wall display
Exhibidor pared autoportante

Os produtos são meramente ilustrativos.
The products are for illustration purposes only.
Los productos que se muestran son a modo ilustrativo.

TRAMONTINA

CHURRASCO

NEW

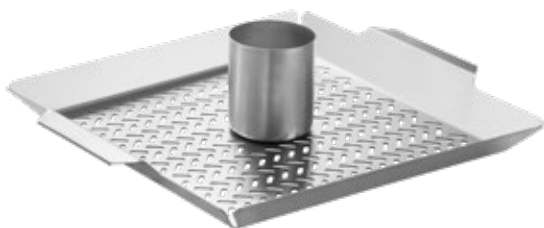

61322/280

Grelha para frango
Poultry roaster
Asadera para pollo

*A=38 cm

*B=32 cm

*C=8,4 cm

NEW



61320/410

Grelha para peixe
Fish tray
Asadera para pescado

*A=48,4 cm

*B=32 cm

*C=3,6 cm





NEW



61321/410
Grelha multiúso
Multi-use tray
Asadera multiuso

*A=47,2 cm
 *B=30,6 cm
 *C=4,9 cm



NEW



62835/440
Disco para grelhar
Round griddle pan
Disco para grillar

*A=54,5 cm
 *B=44 cm
 *C=6 cm

*A = Comprimento / Length / Longitud
 *B = Largura / Width / Ancho
 *C = Altura / Height / Altura

TRAMONTINA

CHURRASCO



A marca de
gestão florestal
responsável
Procure por produtos
certificados FSC®



10496/920
800x500x890 mm | 31.5x19.7x35 inches
FSC Carro Churrasco Grill
FSC Barbecue Serving Cart Grill
FSC Carrito para Asado Grill



10495/920
700x500x890 mm | 27.6x19.7x35 inches
FSC Carro Churrasco Retangular
FSC Rectangular Barbecue Serving Cart
FSC Carrito Asado Rectangular



10493/050
700x500x890 mm | 27.6x19.7x35 inches
Carro Auxiliar - Madeira Teca
Teca Wood Serving Cart
Carrito auxiliar - Madera Teca



13088/920
800x500x850 mm | 31,5 x 19,7 x 33,5 inches
FSC Carro Churrasco com Cepo
FSC Barbecue Serving Cart with knife block
FSC Carrito para Asado Grill con Soporte



A marca da
gestão florestal
responsável
Procure por produtos
certificados FSC®



NEW
13286/640
630 x 450 x 900 mm | 24,8x17,7x35,4 inches
Carro churrasco em madeira mogno africano
Barbecue serving cart in african mahogany wood
Carrito para asado en madera caoba africano



NEW
13285/640
880 x 450 x 900 mm | 34,6x17,7x35,4 inches
Carro churrasco em madeira mogno africano
Barbecue serving cart in african mahogany wood
Carrito para asado en madera caoba africano



13087/920
700x410x850 mm | 27.6x16.1x33.5 inches
FSC Carro churrasco
FSC Barbecue serving cart
FSC Carrito asado



13050/100
500x410x850 mm | 19.7x16.1x33.5 inches
Carro churrasco compact
Compact barbecue serving cart
Carrito para asado compact



CHURRASCO



13054/100
600x400x850 mm | 23.6x15.7x33.5 inches
Bancada para churrasco
Barbecue countertop
Soporte para asado



13198/070
690x450x850 mm | 27.2x17.7x33.5 inches
Carro de churrasco Jatobá
Jatobá barbecue serving cart
Carrito para asado Jatobá



13198/050
690x450x850 mm | 27.2x17.7x33.5 inches
Carro de churrasco teca
Tea barbecue serving cart
Carrito para asado Teca



13210/052
400x210x18 mm | 15.7x8.3x0.7 inches
Tábua para churrasco com cabo
Barbecue board with handle
Tabla con mango para asado



13211/052
460x230x18 mm | 18.1x9.1x0.7 inches
Tábua para churrasco com cabo
Barbecue board with handle
Tabla con mango para asado



13212/052
330x200x18 mm | 13.0x7.9x0.7 inches
Tábua para churrasco retangular 33cm
Retangular barbecue board 33cm
Tabla rectangular para asado 33cm



13213/052
400x240x18 mm | 15.7x9.4x0.7 inches
Tábua para churrasco retangular 40cm
Retangular barbecue board 40cm
Tabla rectangular para asado 40cm



13214/052
490x280x22 mm | 19.3x11.0x0.9 inches
Tábua para churrasco retangular 49cm
Retangular barbecue board 49cm
Tabla rectangular para asado 49cm



13215/052
600x360x22 mm | 23.6x14.2x0.9 inches
Tábua para churrasco retangular 60cm
Retangular barbecue board 60cm
Tabla rectangular para asado 60cm



13216/052
330x200x18 mm | 13.0x7.9x0.7 inches
Tábua para churrasco retangular 33cm
Retangular barbecue board 33cm
Tabla rectangular para asado 33cm



13217/052
400x240x18 mm | 15.7x9.4x0.7 inches
Tábua para churrasco retangular 40cm
Retangular barbecue board 40cm
Tabla rectangular para asado 40cm



13218/052
490x280x22 mm | 19.3x11.0x0.9 inches
Tábua para churrasco retangular 49cm
Retangular barbecue board 49cm
Tabla rectangular para asado 49cm



13219/052
600x360x22 mm | 23.6x14.2x0.9 inches
Tábua para churrasco retangular 60cm
Retangular barbecue board 60cm
Tabla rectangular para asado 60cm



13208/052
400x250x50 mm | 15.7x9.8x2.0 inches
Gamela pequena
Serving dish – small
Fuente de madera – pequeña



13209/052
460x300x50 mm | 18.1x11.8x2.0 inches
Gamela Média
Serving dish – medium
Fuente de madera – mediana



13258/052
350x230x18mm
Tabua retangular – media
Retangular cutting board – medium
Tabla rectangular – mediana



13259/052
400x285x18mm
Tabua retangular – grande
Retangular cutting board – large
Tabla rectangular – grande

TRAMONTINA

CHURRASCO



10268/100
330x200x12 mm | 13.0x7.9x0.5 inches
Tábua churrasco para Cortar e Servir
Cutting and serving board
Tabla para cortar y servir



13168/100
400x270x20 mm | 15.7x10.63x0.78 inches
Tábua para churrasco
Barbecue Board
Tabla para Asado



13068/100 - Médio 430x230x15 mm | 16.9x9.1x0.6 inches
 10063/100 - Grande 460x300x22mm | 18.1x11.8x0.9 inches
 Tábua para Cortar e Servir
 Cutting and serving board
 Tabla para cortar y servir



13169/100
 400x270x20 | 15.7x10.63x0.78 inches
 Tábua para churrasco
 Barbecue Board
 Tabla para Asado



13051/100 - Médio 340x230x15 mm | 13.4x9.1x0.6 inches
 10408/100 - Grande 500x320x22 mm | 19.7x12.6x0.9 inches
 Tábua para Cortar e Servir
 Cutting and serving board
 Tabla para cortar y servir



13069/100
 400x210x12 mm | 15.7x8.3x0.5 inches
 Tábua churrasco para Cortar e Servir
 Cutting and serving board
 Tabla para cortar y servir

TRAMONTINA

CHURRASCO



10039/100 – Pequeno 350x230x15 mm | 13.8x9.1x0.6 inches
10055/100 – Médio 400x270x22 mm | 15.7x10.6x0.9 inches
10057/100 Grande 470x300x22 mm | 18.5x11.8x0.9 inches
Tábua para Cortar e Servir
Cutting and serving board
Tabla para cortar y servir



10066/100
470x307x22 mm | 18.5x12.1x0.9 inches
Tábua para Cortar e Servir
Cutting and serving board
Tabla para cortar y servir

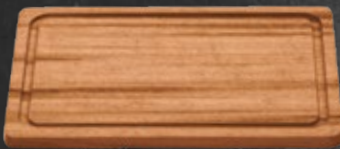

13071/100
300x210x12 mm | 11.8x8.3x0.5 inches
Tábua churrasco para Cortar e Servir
Cutting and serving board
Tabla para cortar y servir



13167/100 | 15.75x10.63x0.78 inches
400x270x20 mm
Tábua para churrasco
Barbecue Board
Tabla para Asado



13053/100
500x350x22mm | 19.7x13.8x0.9 inches
Estação de corte retangular
Barbecue rectangular cutting board
Tabla de corte rectangular para asado





10060/100 - Médio 420x290x22 mm | 16.5x11.4x0.9 inches
10065/100 - Grande 490x280x22 mm | 19.3x11.0x0.9 inches
Tábua para Cortar e Servir
Cutting and serving board
Tabla para cortar y servir



10004/100 - Pequeno \varnothing 230x12 mm | \varnothing 9.1x0.5 inches
10429/100 - Médio \varnothing 260x15 mm | \varnothing 10.2x0.6 inches
Prato churrasco \varnothing 230 mm
Barbecue plate \varnothing 230 mm
Plato para asado \varnothing 230 mm



13176/050 - Médio \varnothing 300x35 mm | \varnothing 11.8 x 1.4 inches
13177/050 - Grande \varnothing 380x35 mm | \varnothing 15 x 1.4 inches
Tábua Madeira Invertida
Inverted Wooden Cutting Board
Tabla de madera invertida



10100/050 - Pequeno 300x300x30 mm | 11.8x11.8x1.2 inches
10101/050 - Médio 400x300x35 mm | 15.7x11.8x1.4 inches
10102/050 - Grande 480x360x40 mm | 18.9x14.2x1.6 inches
Tábua madeira invertida
Inverted wooden cutting board
Tabla de madera invertida

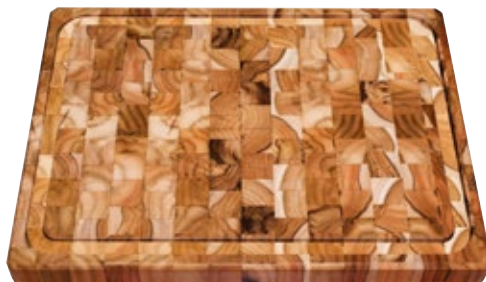

10019/050
500x380x40 mm | 19.7x15.0x1.6 inches
Tábua madeira invertida
Inverted wooden cutting board
Tabla de madera invertida

TRAMONTINA

CHURRASCO



10239/640
400x300x15mm
Petisqueira
Serving dish
Copetinera



13266/052
400x300x15mm
Petisqueira
Serving dish
Copetinera



10239/641
400x300x15mm
Petisqueira
Serving dish
Copetinera



13267/052
240x150x20mm
Petisqueira
Serving dish
Copetinera



13179/100
ø 250x25 mm | ø 9.8x1.0 inches
Petisqueira redonda
Round serving dish
Copetinera redonda



10239/592
ø 300x25 mm | ø 11.8x1.0 inches
Petisqueira redonda com 3 potes
Round serving dish - 3 bowls
Copetinera redonda con 3 bowls



10239/506
200x130x12 mm | 7.9x5.1x0.5 inches
Kit caipirinha basic 05 pç.
Basic caipirinha set 05 pc.
Kit caipiriña basic 05 pz.



10239/510
210x140x15 mm | 8.3x5.5x0.6 inches
Kit caipirinha plus 05 pç.
Plus caipirinha set 05 pc.
Kit Caipiriña plus 05 pz.



10239/382
245x240x12 mm | 9.6x9.4x0.5 inches
Kit caipirinha brasil 04 pç.
Brazilian caipirinha set 04 pc.
Kit caipiriña brasil 04 pz.



TRAMONTINA

CHURRASCO



13260/640
600x400x60mm
Tabua madeira em invertida – grande
End grain butcher block – large
Tabla end grain – grande



13261/640
450x400x45mm
Tabua em madeira invertida – pequena
End grain butcher block – small
Tabla end grain – pequena



13262/640
500x500x60mm
Tabua em madeira invertida – media
End grain butcher block – medium
Tabla end grain – mediana



13263/640
400x400x60mm
Estação de corte madeira invertida
redonda com alça



13264/640
Ø 300x90mm
Gamela em madeira invertida
End grain serving dish
Fuente end grain





CHURRASCO



10239/162
374x253x22 mm | 14.7x10.0x0.9 inches
Mix grill retangular
Rectangular mix grill
Mix grill rectangular



10239/278
480x280x22 mm | 19.0x11.02x0.9 inches
Mix grill retangular com rebaixe
Rectangular mix grill with carve
Mix grill rectangular con rebajo



10239/097
ø 305x185x18 mm | ø 12.0x7.3x0.7 inches
Mix grill oval com alça
Oval mix grill with handle
Mix grill oval con agarre



10239/277
ø 375x22 mm | ø 14.8x0.9 inches
Mix grill redondo com alça
Round mix grill with handle
Mix grill redondo con agarre



10239/098
ø 300x22 mm | ø 11.8x0.9 inches
Mix grill redondo
Round mix grill
Mix grill redondo



10239/639
ø 300x20 mm
Mix grill circular
Round mix grill
Mix grill redondo



10239/638
305x185x20mm
Mix grill oval com alça
Oval mix grill with handle
Mix grill oval con agarre





10400/100
 ø 250x80 mm | ø 9.8x3.1 inches
 Gamela
 Serving dish
 Fuente de madera



10131/100
 ø 350x55 mm | ø 13.8x2.2 inches
 Gamela
 Serving dish
 Fuente de madera



13178/100
 380x200x50 mm | 15.0x7.9x2.0 inches
 Gamela rectangular
 Wooden rectangular serving dish
 Fuente de madera rectangular



10180/100
 400x250x55 mm | 15.7x9.8x2.2 inches
 Gamela rectangular pequena
 Wooden rectangular serving dish
 Fuente de madeira rectangular



10184/100
 400x250x77 mm | 15.7x9.8x3 inches
 Saladeira rectangular média 03 pz.
 Medium wooden serving dish 03 pz.
 Fuente de madeira media 03 pz.



10022/100
 450x300x55 mm | 17.7x11.8x2.2 inches
 Gamela rectangular
 Wooden rectangular serving dish
 Fuente de madeira rectangular



10317/100
 180x180x80 mm | 7.1x7.1x3.1 inches
 Farinheiro
 Container for farinha
 Harinera



13055/100
 140x140x80 mm | 5.5x5.5x3.1 inches
 Saleiro churrasco
 Barbecue saltshaker
 Saleiro para asado



TRAMONTINA

CHURRASCO

Em suas mãos está uma faca que combina **design e arte** para honrar uma história que começou a ser escrita séculos atrás, no sul do Brasil. Mais do que uma homenagem a um **povo que domou o gado e o fogo**, é um presente para você que aprecia o sabor do **autêntico churrasco brasileiro**.

You are holding in your hands a knife that combines **design and art** to honor the history that began being written many centuries ago in southern Brazil. More than an homage to a **people who learned to tame cattle and fire**, this is a gift for you for enjoying the flavor of an **authentic brazilian churrasco**.

En sus manos está un cuchillo que combina **diseño y arte** para honrar una historia que comenzó a escribirse hace siglos, en el sur de Brasil. Más que un homenaje a un **pueblo que domó el ganado y el fuego**, es un regalo para todo el que aprecia el sabor del **auténtico asado brasileño**.





FACAS PARA CHURRASCO JUMBO JUMBO STEAK KNIVES CUCHILLOS PARA ASADO JUMBO

CLASSIC



63928/780

Faca para Churrasco Jumbo de aço inox com serrilha.
Stainless Steel Jumbo Steak knife with serrated edge.
Cuchillo para Asado Jumbo Acero Inoxidable con dientes.



63928/783

Faca para Churrasco Jumbo de aço inox com fio liso.
Stainless Steel Jumbo Steak knife with smooth edge.
Cuchillo para Asado Jumbo Acero Inoxidable con filo liso.



63928/784

Faca para Churrasco Jumbo de aço inox com serrilha e gravação.
Stainless Steel Jumbo Steak knife with serrated edge and engraving.
Cuchillo para Asado Jumbo Acero Inoxidable con dientes y grabado.



63928/785

Faca para Churrasco Jumbo de aço inox com fio liso e gravação.
Stainless Steel Jumbo Steak knife with smooth edge and engraving.
Cuchillo para Asado Jumbo Acero Inoxidable con filo liso y grabado.

TRAMONTINA

CHURRASCO



Conjunto de facas para churrasco Classic 6 peças
6 pc. Stainless steel steak knives set
Juego de cuchillos para asado acero inoxidable 6 pzas.

Conteúdo | Contents | Contenido
6- Facas para churrasco jumbo / Jumbo steak knives /
Cuchillos para asado jumbo

- 66928/595 Serrilha / Serrated edge / Dientes
- 66928/596 Fio liso / Smooth edge / Filo liso
- 66928/597 Serrilha + gravação / Serrated edge + engraving / Dientes + grabado
- 66928/598 Fio liso + gravação / Smooth edge + engraving / Filo liso + grabado



Conjunto de facas para churrasco Classic 6 peças
6 pc. Stainless steel steak knives set
Juego de cuchillos para asado acero inoxidable 6 pzas.

Conteúdo | Contents | Contenido
6- Facas para churrasco jumbo / Jumbo steak knives /
Cuchillos para asado jumbo

- 66928/625 Serrilha / Serrated edge / Dientes
- 66928/626 Fio liso / Smooth edge / Filo liso
- 66928/627 Serrilha + gravação / Serrated edge + engraving / Dientes + grabado
- 66928/628 Fio liso + gravação / Smooth edge + engraving / Filo liso + grabado



Jogo para churrasco Classic 12 peças
12 pc. Stainless steel steak set
Juego para asado acero inoxidable 12 pzas.

Conteúdo | Contents | Contenido
6- Facas para churrasco jumbo / Jumbo steak knives /
Cuchillos para asado jumbo
6- Garfos para churrasco / Steak forks / Tenedores para
asado

- 66928/635 Serrilha / Serrated edge / Dientes
- 66928/636 Fio liso / Smooth edge / Filo liso
- 66928/637 Serrilha + gravação / Serrated edge + engraving / Dientes + grabado
- 66928/638 Fio liso + gravação / Smooth edge + engraving / Filo liso + grabado



63800/685
Pegador para churrasco
Barbecue tong
Pinza para asado

JOGOS DE TALHERES
CUTLERY SETS
JUEGO DE CUBIERTOS



66986/614 - Zuriq
Jogo para churrasco 8 pç.
8 pc. Steak set
Juego para asado 8 pzas.

Conteúdo | Contents | Contenido:
4- Facas para churrasco / Steak knives / Cuchillos para asado
4- Garfos para churrasco / Steak forks / Tenedores para asado

CHURRASCO



66962/614 - Pacific

Jogo para churrasco 8 pç.
8 pc. Steak set
Juego para asado 8 pzas.

Conteúdo | Contents | Contenido:

4- Facas para churrasco / Steak knives / Cuchillos para asado
4- Garfos para churrasco / Steak forks / Tenedores para asado



66912/614 - Sonata

Jogo para churrasco 8 pç.
8 pc. Steak set
Juego para asado 8 pzas.

Conteúdo | Contents | Contenido:

4- Facas para churrasco / Steak knives / Cuchillos para asado
4- Garfos para churrasco / Steak forks / Tenedores para asado



66982/614 - Satri

Jogo para churrasco 8 pç.
8 pc. Steak set
Juego para asado 8 pzas.

Conteúdo | Contents | Contenido:

4- Facas para churrasco / Steak knives / Cuchillos para asado
4- Garfos para churrasco / Steak forks / Tenedores para asado



66925/614 - Firenze

Jogo para churrasco 8 pç.
8 pc. Steak set
Juego para asado 8 pzas.

Conteúdo | Contents | Contenido:

4- Facas para churrasco / Steak knives / Cuchillos para asado
4- Garfos para churrasco / Steak forks / Tenedores para asado



66928/634 - Classic
 Jogo para churrasco 12 pç.
 12 pc. Steak set
 Juego para asado 12 pzas.

Conteúdo | Content | Contenido:

- 6- Facas para churrasco
- 6- Garfos para churrasco
- 6- Steak knives / Cuchillos para asado
- 6- Steak forks / Tenedores para asado



66962/634 - Pacific
 Jogo para churrasco 12 pç.
 12 pc. Steak set
 Juego para asado 12 pzas.

Conteúdo | Contents | Contenido:

- 6- Facas para churrasco / Steak knives / Cuchillos para asado
- 6- Garfos para churrasco / Steak forks / Tenedores para asado



66912/634 - Sonata
 Jogo para churrasco 12 pç.
 12 pc. Steak set
 Juego para asado 12 pzas.

Conteúdo | Contents | Contenido:

- 6- Facas para churrasco / Steak knives / Cuchillos para asado
- 6- Garfos para churrasco / Steak forks / Tenedores para asado



66982/634 - Satri
 Jogo para churrasco 12 pç.
 12 pc. Steak set
 Juego para asado 12 pzas.

Conteúdo | Contents | Contenido:

- 6- Facas para churrasco / Steak knives / Cuchillos para asado
- 6- Garfos para churrasco / Steak forks / Tenedores para asado



66986/634 - Zuriq
 Jogo para churrasco 12 pç.
 12 pc. Steak set
 Juego para asado 12 pzas.

Conteúdo | Contents | Contenido:

- 6- Facas para churrasco / Steak knives / Cuchillos para asado
- 6- Garfos para churrasco / Steak forks / Tenedores para asado



66925/634 - Firenze
 Jogo para churrasco 12 pç.
 12 pc. Steak set
 Juego para asado 12 pzas.

Conteúdo | Contents | Contenido:

- 6- Facas para churrasco / Steak knives / Cuchillos para asado
- 6- Garfos para churrasco / Steak forks / Tenedores para asado



ANOTAÇÕES / NOTES

ANOTAÇÕES / NOTES

Brasil/Brazil

Belém: Fone: (91) 4009.7700
Belo Horizonte: Fone: (31) 3223.4026
Curitiba: Fone: (41) 2111.9110
Goiânia: Fone: (62) 3272.2100
Porto Alegre: Fone: (51) 2101.5000
Recife: Fone: (81) 3128.5500
Rio de Janeiro: Fone: (21) 2224.5004
Salvador: Fone: (71) 3215.8266
São Paulo: Fone: (11) 4197.1266

Exterior / Other countries

Australia: Phone: (61) 2 9674 1799 | Caribe: Phone 507 309 9507
Chile: Phone: 56 (2) 2676.5000 | Colombia: Phone: 57 (1) 623 4500
Ecuador: Phone: 593 (4) 454 1794 | Germany: Phone: 49 (221) 778 999110
Mexico: Phone: 52 (55) 5950 0470 | Panama: Phone: (507) 203 8388
Peru: Phone: 51 (1) 421 2135 | Singapore: Phone: (65) 6635 6264
South Africa: Phone: 27 (11) 300 9500
United Arab Emirates: Phone: 971 (4) 450 4301
United Kingdom (UK): Phone: 44 (0) 20 3176 4558
USA: Phone: 1 (281) 340 8400 | West Africa: Phone: (234) 80 6610 2977



TRAMONTINA